

SUPRIMENTOS INDUSTRIAIS

www.inovasuprisjc.com.br

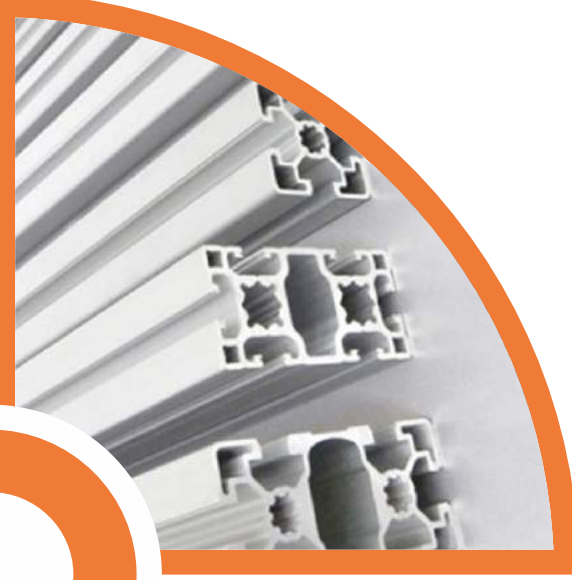

CATÁLOGO

PERFIS

PERFIS INDUSTRIAIS



www.inovasuprisjc.com.br

Av. Marechal Henrique Teixeira Lott, 8460
Vila das Acácias
São José dos Campos-SP

TIPOS DE COLORAÇÃO

PADRÃO RAL
<i>APLICÁVEIS AOS TERMOPLÁSTICOS</i>
Amarelo Limão - 12.362.30
Amarelo RAL 1023 - 15.825.30
Areia - 15.1078.00
Azul Celeste - 17.731.00
Azul Claro RAL 5023 - 17.622.30
Azul Escuro RAL 5005 - 12.004.30
Azul Marinho RAL 5009 - 17.1039.62
Bege RAL 7035 - 11.873.61
Branco RAL 9003 - 18.004.30
Cinza Claro RAL 7039 - 11.673.61
Cinza Escuro RAL 7015
Cinza Especial RAL 7046 - 1046.61
Cinza Médio Escuro RAL 7037
Cinza Médio RAL 7001 - 11.663.61
Laranja RAL 2012 - 14.248.01
Madeira RAL 1001 - 15.835.61
Marron Claro - 11.002.30
Marron Escuro RAL 8028 - 13.211.61
Preto RAL 9004 - 11.002.29
Verde Agua RAL 6019 - 12.411.00
Verde RAL 6024 - 015.1185.021
Vermelho RAL 3000 - 1.400.21

TOLERÂNCIAS DIMENSIONAIS

MEDIDAS (mm)	CLASSE E2 ±
0,00 a 1,50	0,25
1,51 a 2,50	0,35
2,51 a 4,00	0,40
4,01 a 6,30	0,50
6,31 a 10,00	0,70
10,01 a 16,00	0,80
16,01 a 25,00	1,00
25,01 a 40,00	1,30
40,01 a 63,00	1,60
63,01 a 100,00	2,00
acima de 100,00	2,0%

DIN ISO 3302-1



CIA 0501	114 /116	CIA 4023	7 /116	CIA 4057	23 /116	CIA 4091	25 /116	CIA 4125	18 /116
CIA 0504	115 /116	CIA 4024	7 /116	CIA 4058	26 /116	CIA 4092	28 /116	CIA 4126	12 /116
CIA 0505	115 /116	CIA 4025	8 /116	CIA 4059	26 /116	CIA 4093	26 /116	CIA 4127	1 /116
CIA 0506	114 /116	CIA 4026	7 /116	CIA 4060	25 /116	CIA 4094	5 /116	CIA 4129	10 /116
CIA 0507	114 /116	CIA 4027	8 /116	CIA 4061	26 /116	CIA 4095	5 /116	CIA 4130	8 /116
CIA 0508	114 /116	CIA 4028	8 /116	CIA 4062	18 /116	CIA 4096	5 /116	CIA 4131	30 /116
CIA 0511	114 /116	CIA 4029	9 /116	CIA 4063	11 /116	CIA 4097	7 /116	CIA 4132	10 /116
CIA 0512	115 /116	CIA 4030	9 /116	CIA 4064	6 /116	CIA 4098	12 /116	CIA 4133	27 /116
CIA 0513	114 /116	CIA 4031	9 /116	CIA 4065	6 /116	CIA 4099	1 /116	CIA 4134	18 /116
CIA 0514	115 /116	CIA 4032	10 /116	CIA 4066	26 /116	CIA 4100	6 /116	CIA 4135	12 /116
CIA 0515	114 /116	CIA 4033	10 /116	CIA 4067	24 /116	CIA 4101	8 /116	CIA 4136	17 /116
CIA 0516	115 /116	CIA 4034	11 /116	CIA 4068	9 /116	CIA 4102	10 /116	CIA 4137	24 /116
CIA 4001	11 /116	CIA 4035	11 /116	CIA 4069	7 /116	CIA 4103	5 /116	CIA 4138	33 /116
CIA 4002	5 /116	CIA 4036	13 /116	CIA 4070	9 /116	CIA 4104	2 /116	CIA 4139	25 /116
CIA 4003	5 /116	CIA 4037	14 /116	CIA 4071	31 /116	CIA 4105	2 /116	CIA 4140	10 /116
CIA 4004	5 /116	CIA 4038	8 /116	CIA 4072	5 /116	CIA 4106	2 /116	CIA 4141	9 /116
CIA 4005	6 /116	CIA 4039	5 /116	CIA 4073	7 /116	CIA 4107	2 /116	CIA 4142	15 /116
CIA 4006	7 /116	CIA 4040	14 /116	CIA 4074	7 /116	CIA 4108	2 /116	CIA 4143	8 /116
CIA 4007	7 /116	CIA 4041	15 /116	CIA 4075	11 /116	CIA 4109	23 /116	CIA 4144	6 /116
CIA 4008	8 /116	CIA 4042	1 /116	CIA 4076	14 /116	CIA 4110	20 /116	CIA 4145	23 /116
CIA 4009	9 /116	CIA 4043	1 /116	CIA 4077	8 /116	CIA 4111	19 /116	CIA 4146	7 /116
CIA 4010	12 /116	CIA 4044	1 /116	CIA 4078	21 /116	CIA 4112	26 /116	CIA 4147	16 /116
CIA 4011	12 /116	CIA 4045	1 /116	CIA 4079	9 /116	CIA 4113	24 /116	CIA 4148	33 /116
CIA 4012	12 /116	CIA 4046	1 /116	CIA 4080	5 /116	CIA 4114	25 /116	CIA 4149	12 /116
CIA 4013	12 /116	CIA 4047	2 /116	CIA 4081	9 /116	CIA 4115	26 /116	CIA 4150	10 /116
CIA 4014	6 /116	CIA 4048	2 /116	CIA 4082	14 /116	CIA 4116	23 /116	CIA 4151	6 /116
CIA 4015	6 /116	CIA 4049	2 /116	CIA 4083	8 /116	CIA 4117	22 /116	CIA 4152	14 /116
CIA 4016	6 /116	CIA 4050	2 /116	CIA 4084	22 /116	CIA 4118	13 /116	CIA 4153	19 /116
CIA 4017	6 /116	CIA 4051	2 /116	CIA 4085	33 /116	CIA 4119	15 /116	CIA 4154	4 /116
CIA 4018	6 /116	CIA 4052	22 /116	CIA 4086	32 /116	CIA 4120	25 /116	CIA 4155	6 /116
CIA 4019	6 /116	CIA 4053	18 /116	CIA 4087	6 /116	CIA 4121	24 /116	CIA 4156	17 /116
CIA 4020	7 /116	CIA 4054	19 /116	CIA 4088	32 /116	CIA 4122	4 /116	CIA 4157	22 /116
CIA 4021	7 /116	CIA 4055	18 /116	CIA 4089	14 /116	CIA 4123	28 /116	CIA 4158	22 /116
CIA 4022	7 /116	CIA 4056	24 /116	CIA 4090	33 /116	CIA 4124	12 /116	CIA 4159	24 /116

* POLICLOROPRENE (NEOPRENE)

** EPDM

*** NITRILICA

TERMOPLÁSTICO

▲ LOTE MÍNIMO

CIA 4160	20 /116	CIA 4196	14 /116	CIA 4239	24 /116	CIA 4280	6 /116	CIA 4316	21 /116
CIA 4161	30 /116	CIA 4197	14 /116	CIA 4240	13 /116	CIA 4281	1 /116	CIA 4317	4 /116
CIA 4162	2 /116	CIA 4198	15 /116	CIA 4241	18 /116	CIA 4282	1 /116	CIA 4318	29 /116
CIA 4163	17 /116	CIA 4199	23 /116	CIA 4242	11 /116	CIA 4283	32 /116	CIA 4319	26 /116
CIA 4164	7 /116	CIA 4200	7 /116	CIA 4245	17 /116	CIA 4284	32 /116	CIA 4320	23 /116
CIA 4165	25 /116	CIA 4202	22 /116	CIA 4246	7 /116	CIA 4285	4 /116	CIA 4321	3 /116
CIA 4166	33 /116	CIA 4203	15 /116	CIA 4247	17 /116	CIA 4286	23 /116	CIA 4323	22 /116
CIA 4167	4 /116	CIA 4204	21 /116	CIA 4248	17 /116	CIA 4287	16 /116	CIA 4324	4 /116
CIA 4168	18 /116	CIA 4206	21 /116	CIA 4249	21 /116	CIA 4288	9 /116	CIA 4325	8 /116
CIA 4169	19 /116	CIA 4208	9 /116	CIA 4250	11 /116	CIA 4289	14 /116	CIA 4326	23 /116
CIA 4170	1 /116	CIA 4210	1 /116	CIA 4251	20 /116	CIA 4291	32 /116	CIA 4327	1 /116
CIA 4171	19 /116	CIA 4212	25 /116	CIA 4253	17 /116	CIA 4292	32 /116	CIA 4328	8 /116
CIA 4172	23 /116	CIA 4213	9 /116	CIA 4255	11 /116	CIA 4293	32 /116	CIA 4330	1 /116
CIA 4173	27 /116	CIA 4214	15 /116	CIA 4256	30 /116	CIA 4294	33 /116	CIA 4331	6 /116
CIA 4174	29 /116	CIA 4215	17 /116	CIA 4258	24 /116	CIA 4295	18 /116	CIA 4332	22 /116
CIA 4175	19 /116	CIA 4216	21 /116	CIA 4259	13 /116	CIA 4296	30 /116	CIA 4333	17 /116
CIA 4176	13 /116	CIA 4217	30 /116	CIA 4260	1 /116	CIA 4297	1 /116	CIA 4335	10 /116
CIA 4177	34 /116	CIA 4219	21 /116	CIA 4261	6 /116	CIA 4298	4 /116	CIA 4336	26 /116
CIA 4178	34 /116	CIA 4220	1 /116	CIA 4262	17 /116	CIA 4299	4 /116	CIA 4337	8 /116
CIA 4179	31 /116	CIA 4221	10 /116	CIA 4263	17 /116	CIA 4300	10 /116	CIA 4339	19 /116
CIA 4181	13 /116	CIA 4223	30 /116	CIA 4264	8 /116	CIA 4301	27 /116	CIA 4340	19 /116
CIA 4182	15 /116	CIA 4224	12 /116	CIA 4265	16 /116	CIA 4303	24 /116	CIA 4341	22 /116
CIA 4183	2 /116	CIA 4225	19 /116	CIA 4266	5 /116	CIA 4304	27 /116	CIA 4342	14 /116
CIA 4184	17 /116	CIA 4226	20 /116	CIA 4267	6 /116	CIA 4305	27 /116	CIA 4343	5 /116
CIA 4185	17 /116	CIA 4227	1 /116	CIA 4268	18 /116	CIA 4306	19 /116	CIA 4344	16 /116
CIA 4186	13 /116	CIA 4230	1 /116	CIA 4269	26 /116	CIA 4307	17 /116	CIA 4345	22 /116
CIA 4187	1 /116	CIA 4231	1 /116	CIA 4270	28 /116	CIA 4308	19 /116	CIA 4346	31 /116
CIA 4188	18 /116	CIA 4232	9 /116	CIA 4271	18 /116	CIA 4309	28 /116	CIA 4347	6 /116
CIA 4189	22 /116	CIA 4233	23 /116	CIA 4272	34 /116	CIA 4310	22 /116	CIA 4348	25 /116
CIA 4190	28 /116	CIA 4234	7 /116	CIA 4273	34 /116	CIA 4311	4 /116	CIA 4349	24 /116
CIA 4191	12 /116	CIA 4235	19 /116	CIA 4274	33 /116	CIA 4312	23 /116	CIA 4351	17 /116
CIA 4192	6 /116	CIA 4236	9 /116	CIA 4275	33 /116	CIA 4313	28 /116	CIA 4352	23 /116
CIA 4193	18 /116	CIA 4237	1 /116	CIA 4276	13 /116	CIA 4314	29 /116	CIA 4353	10 /116
CIA 4195	19 /116	CIA 4238	22 /116	CIA 4277	9 /116	CIA 4315	22 /116	CIA 4354	30 /116

* POLICLOROPRENE (NEOPRENE)

** EPDM

*** NITRILICA

TERMOPLÁSTICO

▲ LOTE MÍNIMO

CIA 4355	27 /116	CIA 4392	17 /116	CIA 6013	36 /116	CIA 6048	56 /116	CIA 6082	50 /116
CIA 4356	34 /116	CIA 4393	29 /116	CIA 6014	36 /116	CIA 6049	36 /116	CIA 6083	42 /116
CIA 4357	18 /116	CIA 4394	29 /116	CIA 6015	36 /116	CIA 6050	91 /116	CIA 6084	54 /116
CIA 4358	8 /116	CIA 4395	6 /116	CIA 6016	36 /116	CIA 6051	91 /116	CIA 6085	36 /116
CIA 4359	16 /116	CIA 4396	26 /116	CIA 6017	36 /116	CIA 6052	58 /116	CIA 6086	42 /116
CIA 4360	27 /116	CIA 4397	9 /116	CIA 6018	37 /116	CIA 6053	42 /116	CIA 6087	71 /116
CIA 4361	1 /116	CIA 4398	10 /116	CIA 6019	38 /116	CIA 6054	60 /116	CIA 6088	81 /116
CIA 4362	11 /116	CIA 4399	8 /116	CIA 6020	40 /116	CIA 6055	50 /116	CIA 6089	60 /116
CIA 4363	11 /116	CIA 4400	31 /116	CIA 6021	38 /116	CIA 6056	37 /116	CIA 6090	92 /116
CIA 4364	5 /116	CIA 4401	19 /116	CIA 6022	37 /116	CIA 6057	68 /116	CIA 6091	91 /116
CIA 4365	28 /116	CIA 4402	8 /116	CIA 6023	44 /116	CIA 6058	54 /116	CIA 6092	85 /116
CIA 4366	25 /116	CIA 4403	12 /116	CIA 6024	45 /116	CIA 6059	83 /116	CIA 6093	65 /116
CIA 4367	29 /116	CIA 4404	2 /116	CIA 6026	55 /116	CIA 6060	70 /116	CIA 6094	77 /116
CIA 4368	27 /116	CIA 4405	2 /116	CIA 6027	55 /116	CIA 6061	68 /116	CIA 6095	54 /116
CIA 4369	27 /116	CIA 4406	25 /116	CIA 6028	56 /116	CIA 6062	37 /116	CIA 6096	68 /116
CIA 4370	18 /116	CIA 4407	30 /116	CIA 6029	55 /116	CIA 6063	69 /116	CIA 6097	37 /116
CIA 4372	27 /116	CIA 4408	11 /116	CIA 6030	55 /116	CIA 6064	36 /116	CIA 6098	41 /116
CIA 4373	24 /116	CIA 4409	10 /116	CIA 6031	92 /116	CIA 6065	38 /116	CIA 6099	81 /116
CIA 4374	22 /116	CIA 4410	10 /116	CIA 6032	68 /116	CIA 6066	72 /116	CIA 6100	91 /116
CIA 4375	27 /116	CIA 4411	4 /116	CIA 6033	69 /116	CIA 6067	71 /116	CIA 6101	59 /116
CIA 4376	26 /116	CIA 4412	21 /116	CIA 6034	66 /116	CIA 6068	53 /116	CIA 6102	71 /116
CIA 4377	22 /116	CIA 4413	25 /116	CIA 6035	69 /116	CIA 6069	64 /116	CIA 6104	69 /116
CIA 4378	6 /116	CIA 6001	35 /116	CIA 6036	68 /116	CIA 6070	42 /116	CIA 6105	45 /116
CIA 4379	28 /116	CIA 6002	35 /116	CIA 6037	68 /116	CIA 6071	42 /116	CIA 6106	65 /116
CIA 4380	27 /116	CIA 6003	35 /116	CIA 6038	68 /116	CIA 6072	71 /116	CIA 6107	43 /116
CIA 4382	1 /116	CIA 6004	35 /116	CIA 6039	72 /116	CIA 6073	59 /116	CIA 6108	78 /116
CIA 4383	1 /116	CIA 6005	35 /116	CIA 6040	72 /116	CIA 6074	53 /116	CIA 6109	38 /116
CIA 4384	5 /116	CIA 6006	35 /116	CIA 6041	65 /116	CIA 6075	67 /116	CIA 6110	64 /116
CIA 4385	1 /116	CIA 6007	35 /116	CIA 6042	60 /116	CIA 6076	50 /116	CIA 6111	62 /116
CIA 4386	29 /116	CIA 6008	35 /116	CIA 6043	59 /116	CIA 6077	87 /116	CIA 6112	62 /116
CIA 4388	1 /116	CIA 6009	35 /116	CIA 6044	59 /116	CIA 6078	60 /116	CIA 6114	46 /116
CIA 4389	11 /116	CIA 6010	35 /116	CIA 6045	68 /116	CIA 6079	40 /116	CIA 6115	46 /116
CIA 4390	5 /116	CIA 6011	35 /116	CIA 6046	89 /116	CIA 6080	73 /116	CIA 6116	66 /116
CIA 4391	26 /116	CIA 6012	36 /116	CIA 6047	37 /116	CIA 6081	57 /116	CIA 6117	58 /116

* POLICLOROPRENE (NEOPRENE)

** EPDM

*** NITRILICA

TERMOPLÁSTICO

▲ LOTE MÍNIMO

CIA 6118	66 /116	CIA 6154	37 /116	CIA 6193	44 /116	CIA 6227	41 /116	CIA 6263	44 /116
CIA 6119	39 /116	CIA 6155	71 /116	CIA 6194	51 /116	CIA 6228	55 /116	CIA 6264	46 /116
CIA 6120	66 /116	CIA 6156	37 /116	CIA 6195	51 /116	CIA 6229	44 /116	CIA 6265	56 /116
CIA 6121	65 /116	CIA 6157	63 /116	CIA 6196	92 /116	CIA 6230	64 /116	CIA 6266	67 /116
CIA 6122	87 /116	CIA 6158	61 /116	CIA 6197	56 /116	CIA 6231	45 /116	CIA 6267	72 /116
CIA 6124	55 /116	CIA 6159	43 /116	CIA 6198	63 /116	CIA 6233	74 /116	CIA 6268	71 /116
CIA 6125	59 /116	CIA 6160	69 /116	CIA 6199	45 /116	CIA 6234	40 /116	CIA 6269	38 /116
CIA 6126	66 /116	CIA 6161	62 /116	CIA 6200	46 /116	CIA 6235	62 /116	CIA 6270	48 /116
CIA 6127	53 /116	CIA 6162	89 /116	CIA 6201	38 /116	CIA 6236	62 /116	CIA 6271	47 /116
CIA 6128	65 /116	CIA 6163	83 /116	CIA 6202	39 /116	CIA 6237	52 /116	CIA 6272	35 /116
CIA 6129	62 /116	CIA 6164	36 /116	CIA 6203	92 /116	CIA 6238	56 /116	CIA 6273	72 /116
CIA 6130	58 /116	CIA 6165	87 /116	CIA 6204	51 /116	CIA 6239	92 /116	CIA 6274	43 /116
CIA 6131	72 /116	CIA 6166	73 /116	CIA 6205	44 /116	CIA 6241	56 /116	CIA 6275	44 /116
CIA 6132	62 /116	CIA 6167	68 /116	CIA 6206	54 /116	CIA 6242	57 /116	CIA 6276	45 /116
CIA 6133	58 /116	CIA 6169	67 /116	CIA 6207	60 /116	CIA 6243	63 /116	CIA 6277	46 /116
CIA 6135	42 /116	CIA 6170	67 /116	CIA 6208	85 /116	CIA 6244	73 /116	CIA 6278	48 /116
CIA 6136	43 /116	CIA 6171	63 /116	CIA 6209	47 /116	CIA 6245	73 /116	CIA 6279	48 /116
CIA 6137	46 /116	CIA 6172	61 /116	CIA 6210	79 /116	CIA 6246	61 /116	CIA 6280	45 /116
CIA 6138	35 /116	CIA 6173	57 /116	CIA 6211	35 /116	CIA 6247	83 /116	CIA 6281	46 /116
CIA 6139	35 /116	CIA 6174	71 /116	CIA 6212	35 /116	CIA 6248	48 /116	CIA 6282	47 /116
CIA 6140	36 /116	CIA 6177	88 /116	CIA 6213	85 /116	CIA 6249	48 /116	CIA 6283	48 /116
CIA 6141	36 /116	CIA 6178	67 /116	CIA 6214	64 /116	CIA 6250	48 /116	CIA 6284	83 /116
CIA 6142	50 /116	CIA 6179	62 /116	CIA 6215	64 /116	CIA 6251	47 /116	CIA 6285	84 /116
CIA 6143	64 /116	CIA 6180	62 /116	CIA 6216	59 /116	CIA 6252	47 /116	CIA 6286	73 /116
CIA 6144	48 /116	CIA 6181	60 /116	CIA 6217	63 /116	CIA 6253	47 /116	CIA 6287	91 /116
CIA 6145	45 /116	CIA 6182	59 /116	CIA 6218	44 /116	CIA 6254	70 /116	CIA 6288	62 /116
CIA 6146	35 /116	CIA 6183	70 /116	CIA 6219	85 /116	CIA 6255	74 /116	CIA 6289	61 /116
CIA 6147	35 /116	CIA 6186	45 /116	CIA 6220	68 /116	CIA 6256	77 /116	CIA 6290	49 /116
CIA 6148	41 /116	CIA 6187	37 /116	CIA 6221	91 /116	CIA 6257	45 /116	CIA 6291	68 /116
CIA 6149	73 /116	CIA 6188	41 /116	CIA 6222	40 /116	CIA 6258	69 /116	CIA 6293	59 /116
CIA 6150	52 /116	CIA 6189	61 /116	CIA 6223	71 /116	CIA 6259	43 /116	CIA 6294	75 /116
CIA 6151	53 /116	CIA 6190	70 /116	CIA 6224	73 /116	CIA 6260	43 /116	CIA 6295	40 /116
CIA 6152	49 /116	CIA 6191	45 /116	CIA 6225	61 /116	CIA 6261	46 /116	CIA 6297	43 /116
CIA 6153	61 /116	CIA 6192	78 /116	CIA 6226	65 /116	CIA 6262	44 /116	CIA 6298	45 /116

* POLICLOROPRENE (NEOPRENE)

** EPDM

*** NITRILICA

TERMOPLÁSTICO

▲ LOTE MÍNIMO

CIA 6299	46 /116	CIA 6337	63 /116	CIA 6371	52 /116	CIA 6410	55 /116	CIA 6447	77 /116
CIA 6300	73 /116	CIA 6338	56 /116	CIA 6372	66 /116	CIA 6411	85 /116	CIA 6448	71 /116
CIA 6301	59 /116	CIA 6339	90 /116	CIA 6373	63 /116	CIA 6412	59 /116	CIA 6449	43 /116
CIA 6302	52 /116	CIA 6340	90 /116	CIA 6375	93 /116	CIA 6413	50 /116	CIA 6450	45 /116
CIA 6303	61 /116	CIA 6341	80 /116	CIA 6378	64 /116	CIA 6414	40 /116	CIA 6451	84 /116
CIA 6304	35 /116	CIA 6342	64 /116	CIA 6379	43 /116	CIA 6415	40 /116	CIA 6452	72 /116
CIA 6305	61 /116	CIA 6343	51 /116	CIA 6380	85 /116	CIA 6416	76 /116	CIA 6453	46 /116
CIA 6306	53 /116	CIA 6344	45 /116	CIA 6381	66 /116	CIA 6418	50 /116	CIA 6454	54 /116
CIA 6307	55 /116	CIA 6345	91 /116	CIA 6382	69 /116	CIA 6419	74 /116	CIA 6455	64 /116
CIA 6308	55 /116	CIA 6346	83 /116	CIA 6383	59 /116	CIA 6420	71 /116	CIA 6456	76 /116
CIA 6309	54 /116	CIA 6347	37 /116	CIA 6384	36 /116	CIA 6421	87 /116	CIA 6457	58 /116
CIA 6310	45 /116	CIA 6348	67 /116	CIA 6385	61 /116	CIA 6422	78 /116	CIA 6458	42 /116
CIA 6311	42 /116	CIA 6349	62 /116	CIA 6386	40 /116	CIA 6423	76 /116	CIA 6459	63 /116
CIA 6312	83 /116	CIA 6350	37 /116	CIA 6387	40 /116	CIA 6424	64 /116	CIA 6460	69 /116
CIA 6313	60 /116	CIA 6351	93 /116	CIA 6388	38 /116	CIA 6425	42 /116	CIA 6461	37 /116
CIA 6315	61 /116	CIA 6352	51 /116	CIA 6389	72 /116	CIA 6427	64 /116	CIA 6462	68 /116
CIA 6316	41 /116	CIA 6353	62 /116	CIA 6390	66 /116	CIA 6428	59 /116	CIA 6463	77 /116
CIA 6318	69 /116	CIA 6354	65 /116	CIA 6391	67 /116	CIA 6430	55 /116	CIA 6464	44 /116
CIA 6319	63 /116	CIA 6355	61 /116	CIA 6392	71 /116	CIA 6431	36 /116	CIA 6465	63 /116
CIA 6321	38 /116	CIA 6356	38 /116	CIA 6393	72 /116	CIA 6432	60 /116	CIA 6466	44 /116
CIA 6322	59 /116	CIA 6357	73 /116	CIA 6394	58 /116	CIA 6433	37 /116	CIA 6467	36 /116
CIA 6323	70 /116	CIA 6358	37 /116	CIA 6395	44 /116	CIA 6434	67 /116	CIA 6469	60 /116
CIA 6324	42 /116	CIA 6359	78 /116	CIA 6396	66 /116	CIA 6435	75 /116	CIA 6470	60 /116
CIA 6325	43 /116	CIA 6360	64 /116	CIA 6397	79 /116	CIA 6436	65 /116	CIA 6471	42 /116
CIA 6326	49 /116	CIA 6361	43 /116	CIA 6399	63 /116	CIA 6437	78 /116	CIA 6472	56 /116
CIA 6327	69 /116	CIA 6362	84 /116	CIA 6400	62 /116	CIA 6438	78 /116	CIA 6473	43 /116
CIA 6328	83 /116	CIA 6363	88 /116	CIA 6401	50 /116	CIA 6439	60 /116	CIA 6474	43 /116
CIA 6329	69 /116	CIA 6364	52 /116	CIA 6402	50 /116	CIA 6440	59 /116	CIA 6475	94 /116
CIA 6330	40 /116	CIA 6365	53 /116	CIA 6403	66 /116	CIA 6441	75 /116	CIA 6476	71 /116
CIA 6332	69 /116	CIA 6366	52 /116	CIA 6404	93 /116	CIA 6442	46 /116	CIA 6477	44 /116
CIA 6333	62 /116	CIA 6367	80 /116	CIA 6406	59 /116	CIA 6443	69 /116	CIA 6478	78 /116
CIA 6334	41 /116	CIA 6368	55 /116	CIA 6407	81 /116	CIA 6444	68 /116	CIA 6479	42 /116
CIA 6335	67 /116	CIA 6369	90 /116	CIA 6408	65 /116	CIA 6445	70 /116	CIA 6480	58 /116
CIA 6336	36 /116	CIA 6370	63 /116	CIA 6409	45 /116	CIA 6446	84 /116	CIA 6481	81 /116

* POLICLOROPRENE (NEOPRENE)

** EPDM

*** NITRILICA

TERMOPLÁSTICO

▲ LOTE MÍNIMO

CIA 6482	60 /116	CIA 7018	54 /116	CIA 7072	78 /116	CIA 9023	76 /116	CIA 9058	75 /116
CIA 6483	78 /116	CIA 7019	56 /116	CIA 7073	82 /116	CIA 9024	105 /116	CIA 9059	95 /116
CIA 6485	60 /116	CIA 7020	61 /116	CIA 7074	41 /116	CIA 9025	100 /116	CIA 9060	102 /116
CIA 6486	43 /116	CIA 7021	81 /116	CIA 7075	56 /116	CIA 9026	97 /116	CIA 9061	102 /116
CIA 6487	87 /116	CIA 7022	82 /116	CIA 7076	70 /116	CIA 9027	102 /116	CIA 9062	100 /116
CIA 6488	79 /116	CIA 7023	56 /116	CIA 7077	49 /116	CIA 9028	98 /116	CIA 9063	97 /116
CIA 6490	68 /116	CIA 7025	64 /116	CIA 7078	69 /116	CIA 9029	96 /116	CIA 9064	111 /116
CIA 6491	83 /116	CIA 7026	41 /116	CIA 7079	68 /116	CIA 9031	96 /116	CIA 9065	94 /116
CIA 6492	91 /116	CIA 7028	61 /116	CIA 7080	68 /116	CIA 9032	96 /116	CIA 9066	100 /116
CIA 6493	92 /116	CIA 7029	90 /116	CIA 7081	70 /116	CIA 9033	95 /116	CIA 9068	100 /116
CIA 6494	37 /116	CIA 7030	68 /116	CIA 7082	70 /116	CIA 9034	95 /116	CIA 9069	111 /116
CIA 6495	42 /116	CIA 7031	57 /116	CIA 7083	58 /116	CIA 9035	94 /116	CIA 9070	97 /116
CIA 6496	35 /116	CIA 7033	61 /116	CIA 9001	96 /116	CIA 9036	94 /116	CIA 9072	111 /116
CIA 6497	36 /116	CIA 7038	62 /116	CIA 9002	96 /116	CIA 9037	95 /116	CIA 9073	99 /116
CIA 6498	75 /116	CIA 7041	56 /116	CIA 9003	112 /116	CIA 9038	95 /116	CIA 9074	101 /116
CIA 6500	86 /116	CIA 7048	56 /116	CIA 9004	94 /116	CIA 9039	95 /116	CIA 9075	99 /116
CIA 6501	93 /116	CIA 7049	71 /116	CIA 9005	103 /116	CIA 9040	110 /116	CIA 9076	98 /116
CIA 6502	93 /116	CIA 7050	52 /116	CIA 9006	101 /116	CIA 9041	100 /116	CIA 9077	99 /116
CIA 6503	35 /116	CIA 7051	51 /116	CIA 9007	96 /116	CIA 9042	106 /116	CIA 9078	102 /116
CIA 6504	41 /116	CIA 7052	51 /116	CIA 9008	101 /116	CIA 9043	101 /116	CIA 9079	103 /116
CIA 6506	77 /116	CIA 7054	56 /116	CIA 9009	101 /116	CIA 9044	101 /116	CIA 9080	99 /116
CIA 6507	77 /116	CIA 7055	38 /116	CIA 9010	102 /116	CIA 9045	100 /116	CIA 9081	98 /116
CIA 6508	93 /116	CIA 7056	70 /116	CIA 9011	101 /116	CIA 9046	98 /116	CIA 9082	100 /116
CIA 6509	65 /116	CIA 7057	56 /116	CIA 9012	95 /116	CIA 9047	94 /116	CIA 9083	107 /116
CIA 6510	37 /116	CIA 7058	55 /116	CIA 9013	100 /116	CIA 9048	94 /116	CIA 9084	95 /116
CIA 7002	56 /116	CIA 7059	61 /116	CIA 9014	94 /116	CIA 9049	98 /116	CIA 9085	94 /116
CIA 7004	67 /116	CIA 7060	63 /116	CIA 9015	94 /116	CIA 9050	102 /116	CIA 9086	98 /116
CIA 7006	73 /116	CIA 7061	64 /116	CIA 9016	97 /116	CIA 9051	111 /116	CIA 9087	97 /116
CIA 7008	69 /116	CIA 7064	44 /116	CIA 9017	76 /116	CIA 9052	96 /116	CIA 9088	112 /116
CIA 7009	67 /116	CIA 7065	56 /116	CIA 9018	94 /116	CIA 9053	101 /116	CIA 9089	95 /116
CIA 7010	70 /116	CIA 7066	59 /116	CIA 9019	98 /116	CIA 9054	97 /116	CIA 9090	95 /116
CIA 7013	35 /116	CIA 7069	57 /116	CIA 9020	113 /116	CIA 9055	95 /116	CIA 9091	96 /116
CIA 7014	62 /116	CIA 7070	63 /116	CIA 9021	98 /116	CIA 9056	95 /116	CIA 9092	110 /116
CIA 7016	55 /116	CIA 7071	35 /116	CIA 9022	101 /116	CIA 9057	101 /116	CIA 9093	76 /116

* POLICLOROPRENE (NEOPRENE)

** EPDM

*** NITRILICA

TERMOPLÁSTICO

▲ LOTE MÍNIMO

CIA 9094	101 /116	CIA 9133	95 /116	CIA 14120	66 /116	CIA 14537	28 /116	CIA 14943	84 /116
CIA 9095	99 /116	CIA 9134	79 /116	CIA 14121	25 /116	CIA 14554	39 /116	CIA 14954	54 /116
CIA 9096	106 /116	CIA 9138	97 /116	CIA 14170	71 /116	CIA 14555	38 /116	CIA 15006	31 /116
CIA 9097	109 /116	CIA 9139	104 /116	CIA 14199	100 /116	CIA 14556	5 /116	CIA 15020	31 /116
CIA 9098	101 /116	CIA 9140	108 /116	CIA 14205	45 /116	CIA 14578	69 /116	CIA 15024	30 /116
CIA 9100	104 /116	CIA 9141	98 /116	CIA 14229	28 /116	CIA 14579	40 /116	CIA 15031	104 /116
CIA 9102	105 /116	CIA 9142	103 /116	CIA 14244	115 /116	CIA 14599	1 /116	CIA 15048	71 /116
CIA 9103	97 /116	CIA 9143	99 /116	CIA 14250	57 /116	CIA 14619	49 /116	CIA 15057	76 /116
CIA 9106	102 /116	CIA 9144	80 /116	CIA 14251	18 /116	CIA 14625	70 /116	CIA 15063	5 /116
CIA 9107	98 /116	CIA 9145	109 /116	CIA 14252	75 /116	CIA 14631	115 /116	CIA 15073	80 /116
CIA 9108	94 /116	CIA 9146	94 /116	CIA 14260	49 /116	CIA 14632	115 /116	CIA 15075	86 /116
CIA 9109	98 /116	CIA 9147	106 /116	CIA 14261	100 /116	CIA 14664	102 /116	CIA 15082	104 /116
CIA 9111	103 /116	CIA 9148	107 /116	CIA 14263	100 /116	CIA 14697	107 /116	CIA 15127	80 /116
CIA 9112	96 /116	CIA 9149	93 /116	CIA 14299	102 /116	CIA 14803	96 /116	CIA 15169	12 /116
CIA 9113	102 /116	CIA 9151	95 /116	CIA 14317	58 /116	CIA 14804	104 /116	CIA 15234	68 /116
CIA 9114	107 /116	CIA 9152	110 /116	CIA 14320	20 /116	CIA 14812	2 /116	CIA 15235	68 /116
CIA 9115	105 /116	CIA 9153	110 /116	CIA 14341	5 /116	CIA 14813	3 /116	CIA 15236	68 /116
CIA 9116	80 /116	CIA 9154	82 /116	CIA 14360	44 /116	CIA 14814	3 /116	CIA 15237	68 /116
CIA 9117	81 /116	CIA 9155	49 /116	CIA 14365	58 /116	CIA 14832	57 /116	CIA 15251	65 /116
CIA 9118	79 /116	CIA 9156	93 /116	CIA 14379	76 /116	CIA 14833	56 /116	CIA 15379	25 /116
CIA 9119	97 /116	CIA 9157	96 /116	CIA 14380	76 /116	CIA 14835	69 /116	CIA 15404	82 /116
CIA 9120	105 /116	CIA 9158	106 /116	CIA 14381	76 /116	CIA 14836	63 /116	CIA 15423	112 /116
CIA 9121	108 /116	CIA 9159	106 /116	CIA 14383	38 /116	CIA 14837	70 /116	CIA 15442	116 /116
CIA 9122	94 /116	CIA 9160	104 /116	CIA 14407	2 /116	CIA 14838	60 /116	CIA 15456	31 /116
CIA 9123	110 /116	CIA 9161	107 /116	CIA 14408	2 /116	CIA 14840	55 /116	CIA 15457	31 /116
CIA 9124	84 /116	CIA 9162	38 /116	CIA 14409	3 /116	CIA 14841	95 /116	CIA 15467	105 /116
CIA 9125	94 /116	CIA 14029	66 /116	CIA 14410	3 /116	CIA 14842	93 /116	CIA 15623	53 /116
CIA 9126	106 /116	CIA 14037	42 /116	CIA 14413	65 /116	CIA 14847	98 /116	CIA 15634	70 /116
CIA 9127	105 /116	CIA 14065	91 /116	CIA 14450	67 /116	CIA 14851	19 /116	CIA 15703	58 /116
CIA 9128	102 /116	CIA 14070	76 /116	CIA 14453	58 /116	CIA 14882	112 /116	CIA 15710	25 /116
CIA 9129	109 /116	CIA 14088	68 /116	CIA 14454	58 /116	CIA 14917	36 /116	CIA 15711	57 /116
CIA 9130	108 /116	CIA 14089	50 /116	CIA 14518	69 /116	CIA 14937	70 /116	CIA 15750	57 /116
CIA 9131	109 /116	CIA 14114	67 /116	CIA 14526	65 /116	CIA 14940	2 /116	CIA 15780	57 /116
CIA 9132	85 /116	CIA 14117	65 /116	CIA 14534	28 /116	CIA 14941	2 /116	CIA 15781	72 /116

* POLICLOROPRENE (NEOPRENE)

** EPDM

*** NITRILICA

TERMOPLÁSTICO

▲ LOTE MÍNIMO

CIA 15811	30 /116	CIA 16300	57 /116	CIA 16591	16 /116	CIA 16774	5 /116	CIA 17090	26 /116
CIA 15814	7 /116	CIA 16311	72 /116	CIA 16592	25 /116	CIA 16778	67 /116	CIA 17095	37 /116
CIA 15818	70 /116	CIA 16313	72 /116	CIA 16599	9 /116	CIA 16779	67 /116	CIA 17134	23 /116
CIA 15819	62 /116	CIA 16314	72 /116	CIA 16601	26 /116	CIA 16780	19 /116	CIA 17171	50 /116
CIA 15825	86 /116	CIA 16315	72 /116	CIA 16602	8 /116	CIA 16787	18 /116	CIA 17172	52 /116
CIA 15826	86 /116	CIA 16316	72 /116	CIA 16604	28 /116	CIA 16789	5 /116	CIA 17173	70 /116
CIA 15827	86 /116	CIA 16326	55 /116	CIA 16618	58 /116	CIA 16801	52 /116	CIA 17202	14 /116
CIA 15875	95 /116	CIA 16327	73 /116	CIA 16628	39 /116	CIA 16805	66 /116	CIA 17217	67 /116
CIA 15883	40 /116	CIA 16329	42 /116	CIA 16641	24 /116	CIA 16806	55 /116	CIA 17222	57 /116
CIA 15887	50 /116	CIA 16379	23 /116	CIA 16642	26 /116	CIA 16817	52 /116	CIA 17237	51 /116
CIA 15895	25 /116	CIA 16386	1 /116	CIA 16647	1 /116	CIA 16818	72 /116	CIA 17246	24 /116
CIA 15937	22 /116	CIA 16428	38 /116	CIA 16653	13 /116	CIA 16825	26 /116	CIA 17258	39 /116
CIA 15973	103 /116	CIA 16436	66 /116	CIA 16656	6 /116	CIA 16833	7 /116	CIA 17265	3 /116
CIA 15974	96 /116	CIA 16440	24 /116	CIA 16658	19 /116	CIA 16844	8 /116	CIA 17266	3 /116
CIA 15980	53 /116	CIA 16453	52 /116	CIA 16659	52 /116	CIA 16859	9 /116	CIA 17267	3 /116
CIA 16000	41 /116	CIA 16462	37 /116	CIA 16665	23 /116	CIA 16866	22 /116	CIA 17268	3 /116
CIA 16010	43 /116	CIA 16463	38 /116	CIA 16666	71 /116	CIA 16867	58 /116	CIA 17269	3 /116
CIA 16011	43 /116	CIA 16464	37 /116	CIA 16668	38 /116	CIA 16868	35 /116	CIA 17314	66 /116
CIA 16012	44 /116	CIA 16473	51 /116	CIA 16673	1 /116	CIA 16892	70 /116	CIA 17325	49 /116
CIA 16022	113 /116	CIA 16474	53 /116	CIA 16674	24 /116	CIA 16897	66 /116	CIA 17327	60 /116
CIA 16031	86 /116	CIA 16483	74 /116	CIA 16677	20 /116	CIA 16958	29 /116	CIA 17332	55 /116
CIA 16032	37 /116	CIA 16526	3 /116	CIA 16679	50 /116	CIA 16961	13 /116	CIA 17340	50 /116
CIA 16081	16 /116	CIA 16527	2 /116	CIA 16688	19 /116	CIA 16964	21 /116	CIA 17372	8 /116
CIA 16083	64 /116	CIA 16529	38 /116	CIA 16705	4 /116	CIA 16979	1 /116	CIA 17376	11 /116
CIA 16118	44 /116	CIA 16536	65 /116	CIA 16707	54 /116	CIA 16992	16 /116	CIA 17387	54 /116
CIA 16170	1 /116	CIA 16552	24 /116	CIA 16708	54 /116	CIA 16998	21 /116	CIA 17389	47 /116
CIA 16176	70 /116	CIA 16559	36 /116	CIA 16721	57 /116	CIA 17011	40 /116	CIA 17406	26 /116
CIA 16198	39 /116	CIA 16564	53 /116	CIA 16741	22 /116	CIA 17012	63 /116	CIA 17431	9 /116
CIA 16211	45 /116	CIA 16566	37 /116	CIA 16746	57 /116	CIA 17049	52 /116	CIA 17433	45 /116
CIA 16212	55 /116	CIA 16568	7 /116	CIA 16749	5 /116	CIA 17058	10 /116	CIA 17437	23 /116
CIA 16238	57 /116	CIA 16569	13 /116	CIA 16750	42 /116	CIA 17063	42 /116		
CIA 16249	39 /116	CIA 16574	61 /116	CIA 16751	42 /116	CIA 17067	4 /116		
CIA 16266	57 /116	CIA 16587	50 /116	CIA 16768	11 /116	CIA 17069	2 /116		
CIA 16298	74 /116	CIA 16590	37 /116	CIA 16770	44 /116	CIA 17072	64 /116		









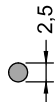

* POLICLOROPRENE (NEOPRENE)

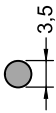



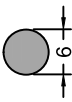
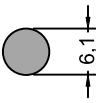
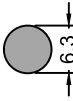
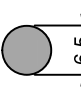
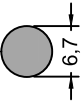
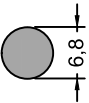
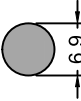

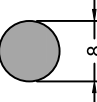

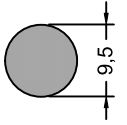
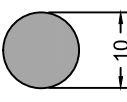
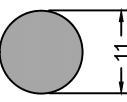
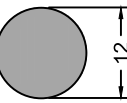
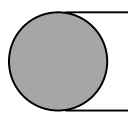
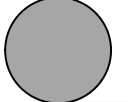
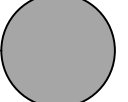

** EPDM

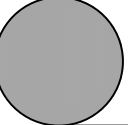
*** NITRILICA

TERMOPLÁSTICO



▲ LOTE MÍNIMO



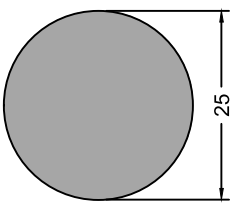
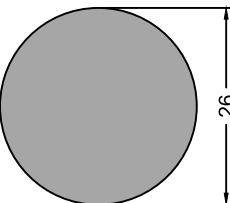
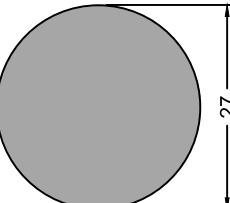
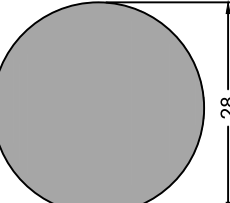
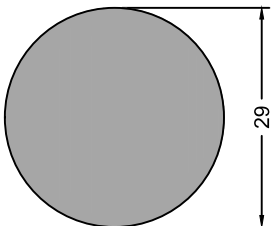
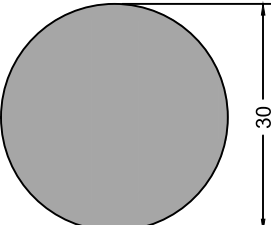
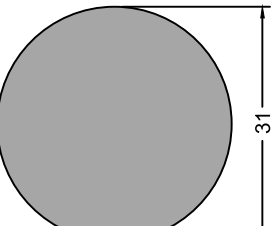
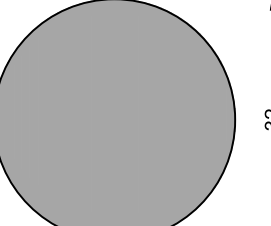
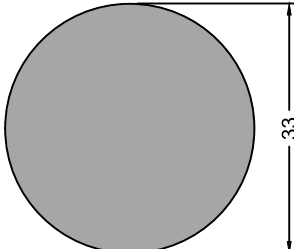
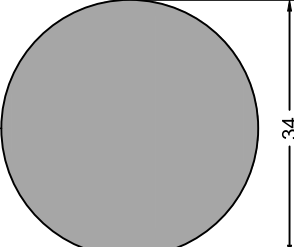
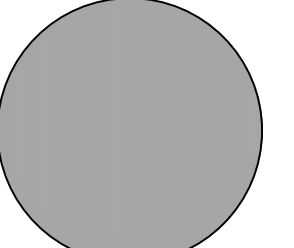

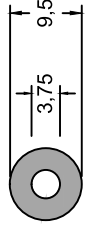
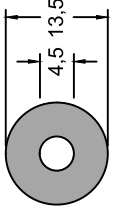
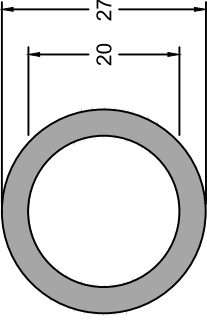
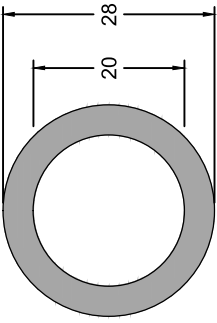
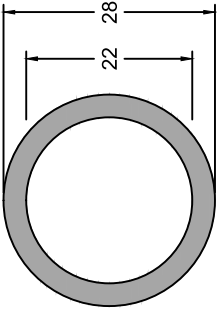
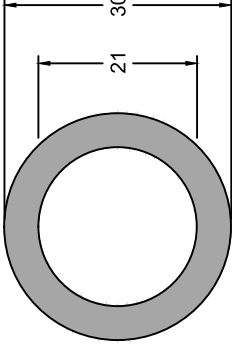
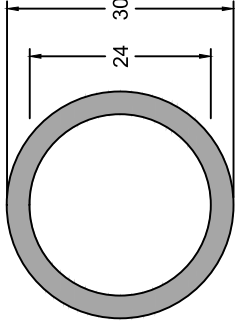
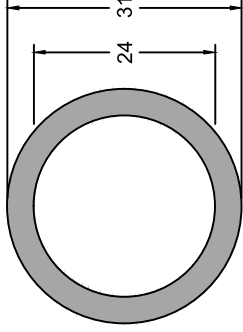
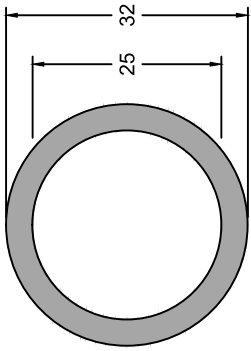
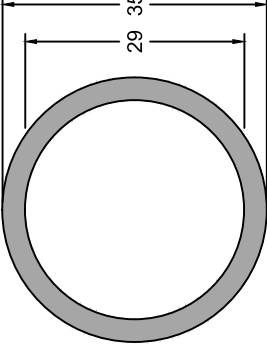
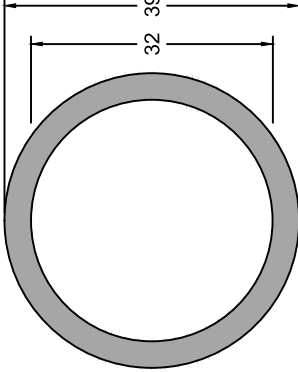
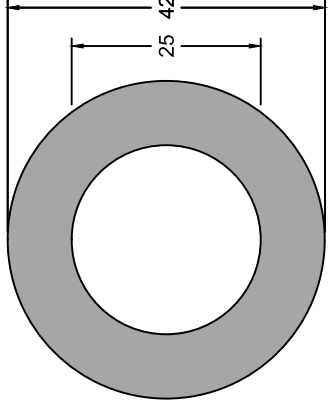

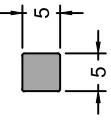
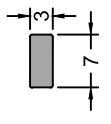
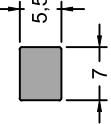
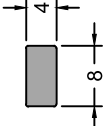
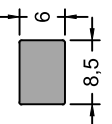
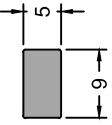
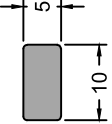
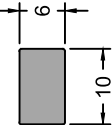
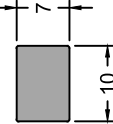
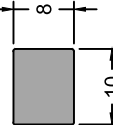
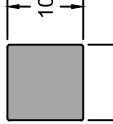
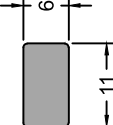

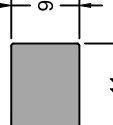
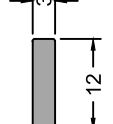
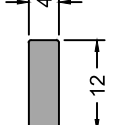
<p>CIA 4187 (15 Shore A)</p>  <p>2,5</p>	<p>CIA 4220 (15 Shore A) CIA 4297 CIA 4330**</p>  <p>3</p>	<p>CIA 4127 CIA 4282 (5 Shore A - Bege) CIA 4210 (15 Shore A)</p>  <p>3,5</p>	<p>CIA 4099 CIA 16170** CIA 4237 (15 Shore A) CIA 16386** (15 Shore A)</p>  <p>4</p>
<p>CIA 4361 CIA 14599 (5 Shore A - Bege)</p>  <p>4,5</p>	<p>CIA 4042 CIA 4231** (15 Shore A)</p>  <p>5</p>	<p>CIA 4043 CIA 16647 (30 Shore A)</p>  <p>6</p>	<p>CIA 4327 (30 Shore A Branco)</p>  <p>6,1</p>
<p>CIA 4227 (15 Shore A) CIA 4260 (5 Shore A - Cinza)</p>  <p>6,3</p>	<p>CIA 4170 CIA 4281 (5 Shore A - Bege) CIA 4383** (30 Shore A)</p>  <p>6,5</p>	<p>CIA 4385 (5 Shore A - Bege)</p>  <p>6,7</p>	<p>CIA 16673 (30 Shore A - Bege)</p>  <p>6,8</p>
<p>CIA 16979 (5 Shore A - Bege)</p>  <p>6,9</p>	<p>CIA 4044 CIA 4230**</p>  <p>7</p>	<p>CIA 4045 CIA 4388**</p>  <p>8</p>	<p>CIA 4046 CIA 4382** (30 Shore A)</p>  <p>9</p>

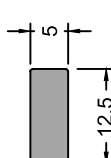
<p>CIA 4162</p>  <p>9.5</p>	<p>CIA 4047 CIA 14940 (30 Shore A)</p>  <p>10</p>	<p>CIA 4048 CIA 4183 (15 Shore A)</p>  <p>11</p>	<p>CIA 4049 CIA 14941 (30 Shore A)</p>  <p>12</p>
<p>CIA 4050</p>  <p>13</p>	<p>CIA 4104</p>  <p>14</p>	<p>CIA 4105 CIA 4404 (30 Shore A)</p>  <p>15</p>	<p>CIA 4051</p>  <p>16</p>
<p>CIA 4405 (30 Shore A) CIA 14407</p>  <p>17</p>	<p>CIA 4106</p>  <p>18</p>	<p>CIA 4107</p>  <p>19</p>	<p>CIA 4108</p>  <p>20</p>
<p>CIA 17069</p>  <p>21</p>	<p>CIA 14408</p>  <p>22</p>	<p>CIA 16527</p>  <p>23</p>	<p>CIA 14812</p>  <p>24</p>

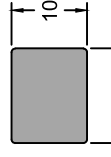
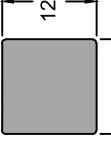
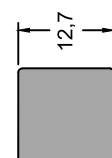
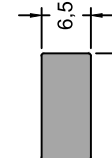
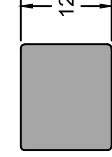
<p>CIA 4321</p>  <p>25</p>	<p>CIA 14409</p>  <p>26</p>	<p>CIA 16526</p>  <p>27</p>	<p>CIA 14410</p>  <p>28</p>
<p>CIA 14813</p>  <p>29</p>	<p>CIA 17265</p>  <p>30</p>	<p>CIA 17266</p>  <p>31</p>	<p>CIA 14814</p>  <p>32</p>
<p>CIA 17267</p>  <p>33</p>	<p>CIA 17268</p>  <p>34</p>	<p>CIA 17269</p>  <p>35</p>	

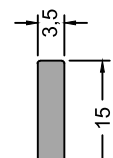
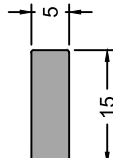
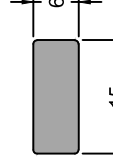
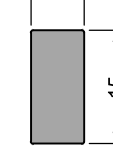
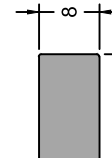

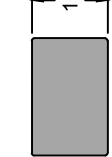

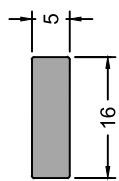
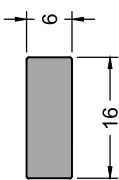
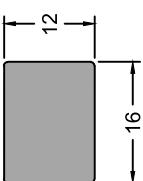
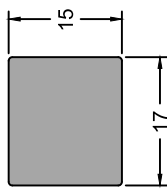
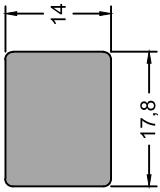
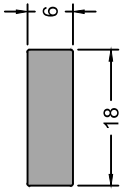
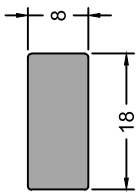
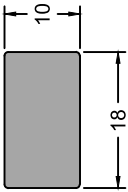
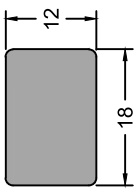
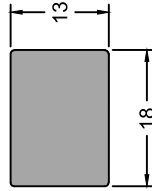
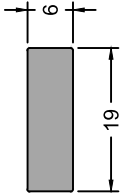
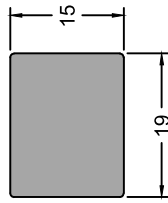
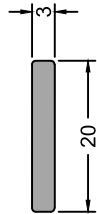
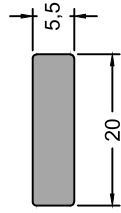
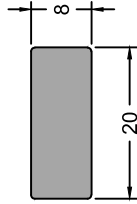
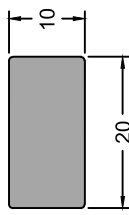

<p>CIA 4311** (15 Shore A)</p> 	<p>CIA 17067** (15 Shore A)</p> 	<p>CIA 16705** (30 Shore A)</p> 	<p>CIA 4167 (15 Shore A)</p> 
<p>CIA 4299 (15 Shore A)</p> 	<p>CIA 4324 (15 Shore A)</p> 	<p>CIA 4285** (30 Shore A)</p> 	<p>CIA 4317** (30 Shore A)</p> 
<p>CIA 4122** (30 Shore A)</p> 	<p>CIA 4411** (30 Shore A)</p> 	<p>CIA 4154** (30 Shore A)</p> 	<p>CIA 4298** (30 Shore A)</p> 

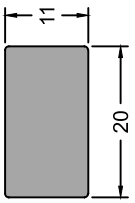
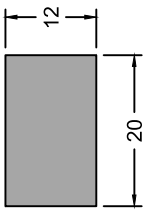
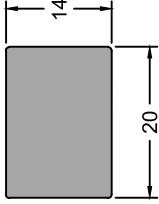
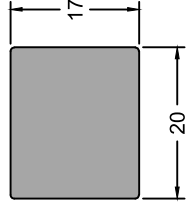
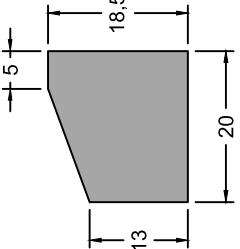
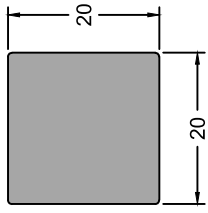
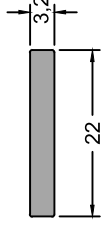
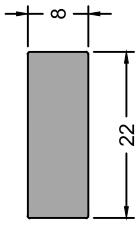
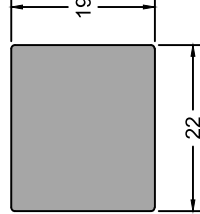
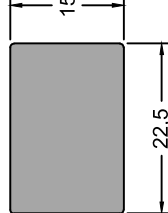
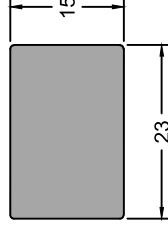
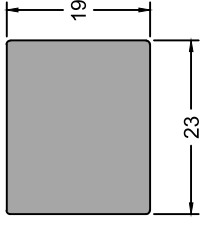
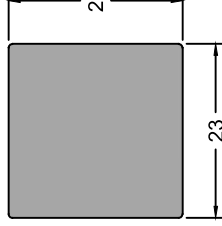
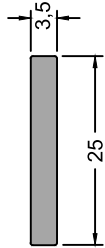
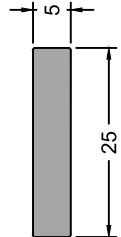
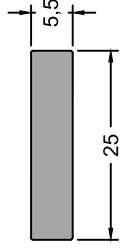

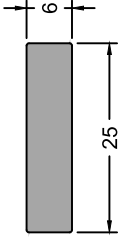
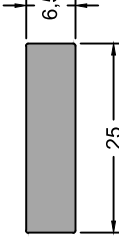
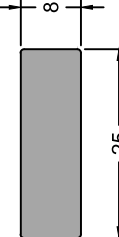
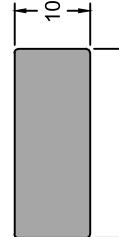
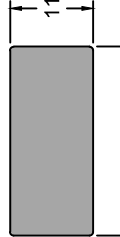
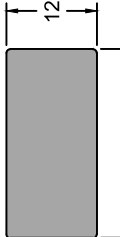
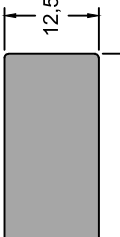
<p>CIA 15063**</p> 	<p>CIA 4002</p> 	<p>CIA 14556 CIA 16749 (15 Shore A)</p> 	<p>CIA 4103</p> 
<p>CIA 16789**</p> 	<p>CIA 4096</p> 	<p>CIA 4266** (10 Shore A -Bege)</p> 	<p>CIA 4003</p> 
<p>CIA 4004 CIA 4343** CIA 16774 (15 Shore A)</p> 	<p>CIA 4094</p> 	<p>CIA 4080 CIA 4390** (15 Shore A Cinza)</p> 	<p>CIA 14341** (12 Shore A)</p> 
<p>CIA 4364** (15 Shore A -Bege) CIA 4384** (15 Shore A -Cinza)</p> 	<p>CIA 4095</p> 	<p>CIA 4039</p> 	<p>CIA 4072</p> 

<p>CIA 4064 CIA 4347**</p> 	<p>CIA 4331**</p> 	<p>CIA 4087</p> 	<p>CIA 4065</p> 
<p>CIA 4155**</p> 	<p>CIA 4100** (35 Shore A) ▲</p> 	<p>CIA 4144</p> 	<p>CIA 4005</p> 
<p>CIA 4014</p> 	<p>CIA 4015 CIA 4261** CIA 4267** (Bege) ▲</p> 	<p>CIA 4151 CIA 4395** (30 Shore A) ▲</p> 	<p>CIA 4192</p> 
<p>CIA 4018 CIA 4280 (15 Shore A) CIA 4378**</p> 	<p>CIA 4016</p> 	<p>CIA 4017 CIA 16656**</p> 	<p>CIA 4019</p> 

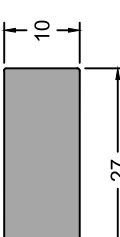
<p>CIA 4164</p> 	<p>CIA 4200</p> 	<p>CIA 4097</p> 	<p>CIA 4022</p> 
<p>CIA 4074 (15 Shore A)</p> 	<p>CIA 4146** (15 Shore A) CIA 16833**</p> 	<p>CIA 4020</p> 	<p>CIA 4021 CIA 4073 (30 Shore A) ▲</p> 
<p>CIA 16568**</p> 	<p>CIA 4006</p> 	<p>CIA 4007 CIA 4234 (5 Shore A - Cinza) ▲</p> 	<p>CIA 4023</p> 
<p>CIA 15814** (15 Shore A - Cinza)</p> 	<p>CIA 4069</p> 	<p>CIA 4024</p> 	<p>CIA 4026 CIA 4246 (15 Shore A)</p> 

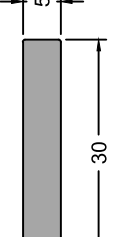
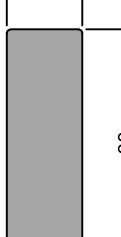
<p>CIA 16844 (30 Shore A)</p> 	<p>CIA 4337** (CINZA) ▲</p> 	<p>CIA 4083</p> 	<p>CIA 4399</p> 
<p>CIA 4328* ▲</p> 	<p>CIA 4025</p> 	<p>CIA 4130 CIA 4325**</p> 	<p>CIA 4038</p> 
<p>CIA 4027 CIA 4101** ▲</p> 	<p>CIA 4264</p> 	<p>CIA 4402</p> 	<p>CIA 17372</p> 
<p>CIA 16602**</p> 	<p>CIA 4028 CIA 4358**</p> 	<p>CIA 4077</p> 	<p>CIA 4008 CIA 4143**</p> 

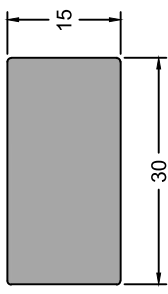
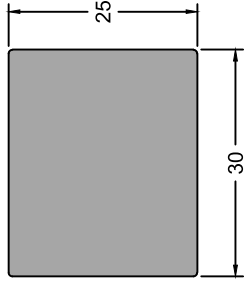
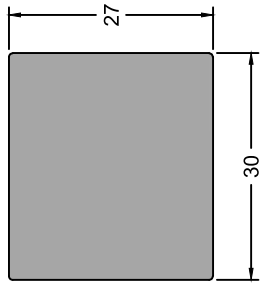
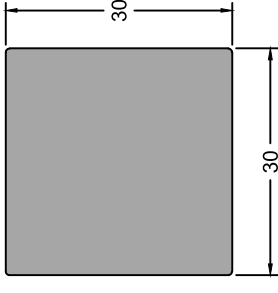
<p>CIA 16859** (15 Shore A)</p> 	<p>CIA 4232 CIA 4141** (15 Shore A - Cinza) ▲</p> 	<p>CIA 4288</p> 	<p>CIA 4277</p> 
<p>CIA 4236* ▲</p> 	<p>CIA 4070</p> 	<p>CIA 4009</p> 	<p>CIA 4081</p> 
<p>CIA 4031 CIA 16599**</p> 	<p>CIA 4213**</p> 	<p>CIA 4029 CIA 4208 (30 Shore A) ▲</p> 	<p>CIA 4397**</p> 
<p>CIA 4030</p> 	<p>CIA 4068</p> 	<p>CIA 4079</p> 	<p>CIA 17431</p> 

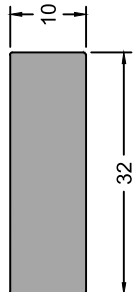
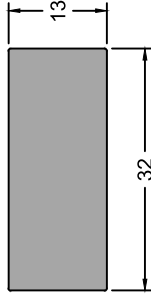
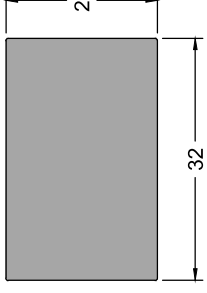
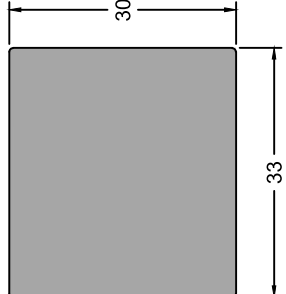
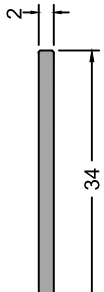
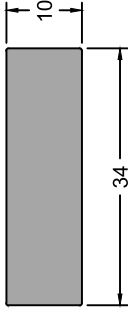
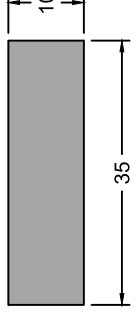
<p>CIA 4132 CIA 17058** (15 Shore A)</p> 	<p>CIA 4102 CIA 4353 (15 Shore A)</p> 	<p>CIA 4335</p> 	<p>CIA 4150 CIA 4300 (30 Shore A) ▲</p> 
<p>CIA 4032</p> 	<p>CIA 4033</p> 	<p>CIA 4140</p> 	<p>CIA 4221</p> 
<p>CIA 4410 (15 shore A)</p> 	<p>CIA 4129**</p> 	<p>CIA 4398**</p> 	<p>CIA 4409**</p> 

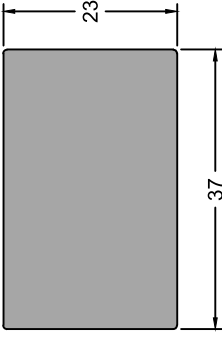
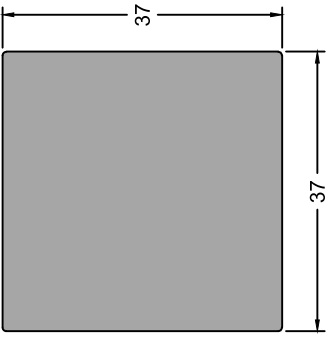
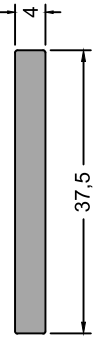
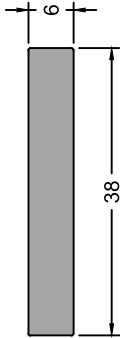
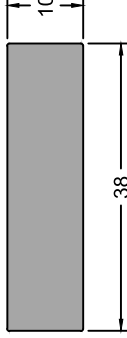
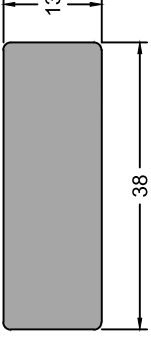
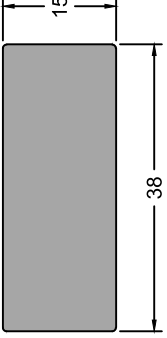
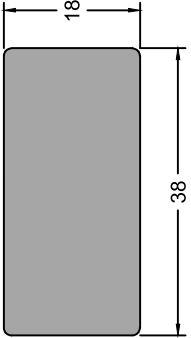
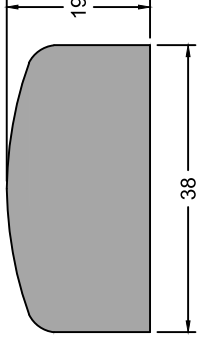
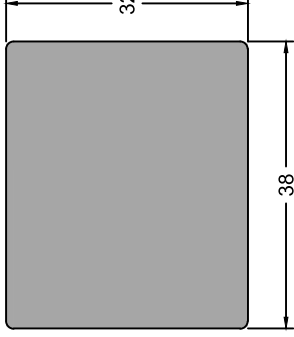
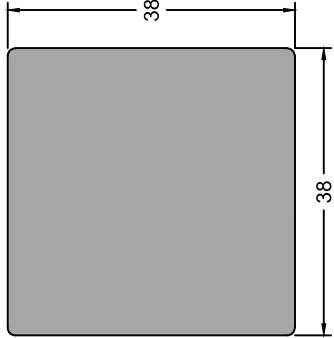
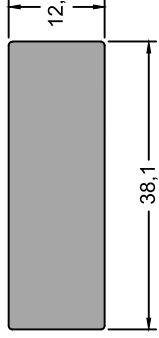
<p>CIA 4408</p> 	<p>CIA 17376**</p> 	<p>CIA 4034</p> 	<p>CIA 4035 CIA 4242 (5 Shore A - Cinza) ▲</p> 
<p>CIA 4063</p> 	<p>CIA 4250*** (30 Shore A) ▲</p> 	<p>CIA 4075</p> 	<p>CIA 4255</p> 
<p>CIA 4001</p> 	<p>CIA 4363 (15 Shore A) ▲</p> 	<p>CIA 4362 (15 Shore A) CIA 4389</p> 	<p>CIA 16768</p> 

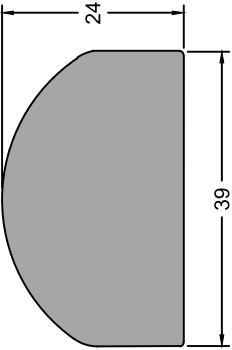
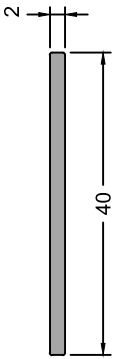
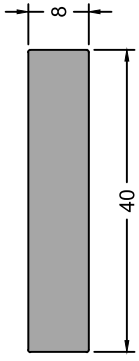
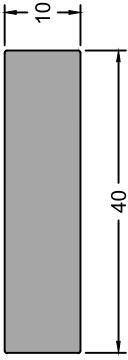
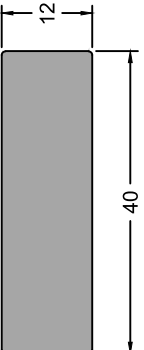
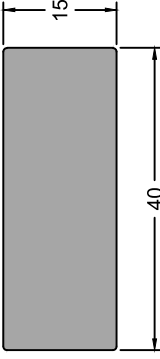
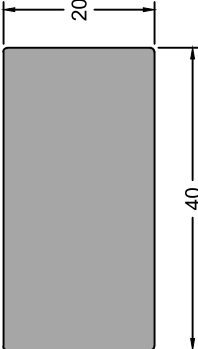
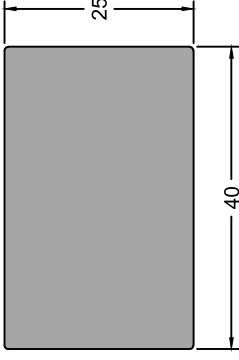
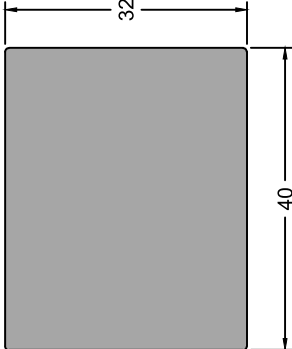
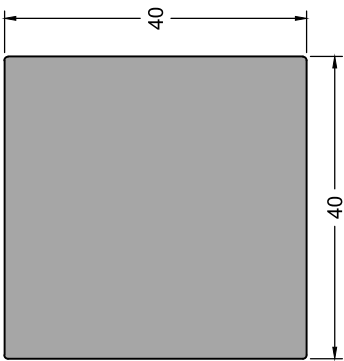
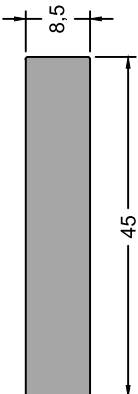
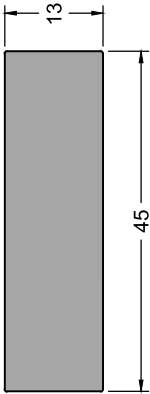
<p>CIA 4098</p> 	<p>CIA 4124</p> 	<p>CIA 4149</p> 	<p>CIA 4012</p> 
<p>CIA 4011</p> 	<p>CIA 4403</p> 	<p>CIA 4010 CIA 15169**</p> 	<p>CIA 4224</p> 
<p>CIA 4126</p> 	<p>CIA 4135</p> 	<p>CIA 4013</p> 	<p>CIA 4191</p> 

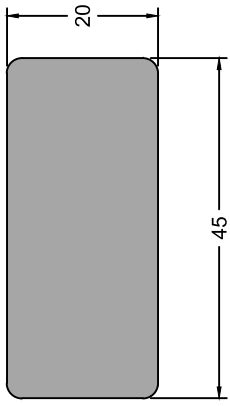
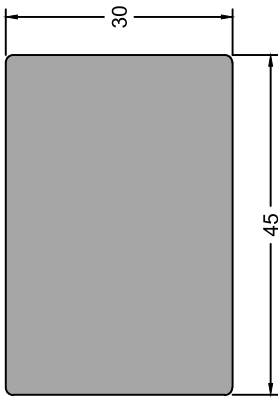
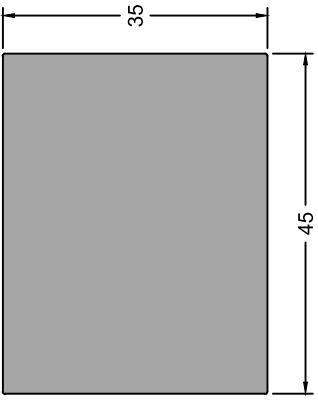
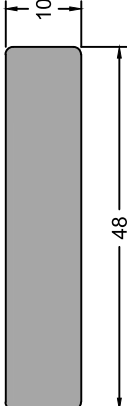
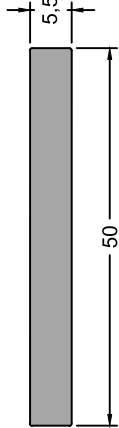
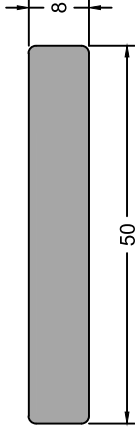
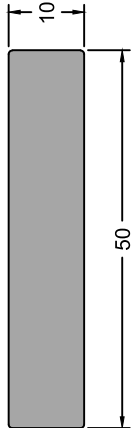
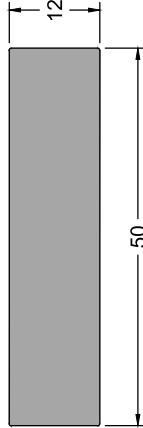
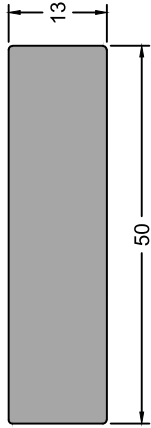
<p>CIA 16653 (35 Shore A)</p> 	<p>CIA 4118</p> 	<p>CIA 4181</p> 
<p>CIA 4259</p> 	<p>CIA 4036 CIA 4186 (15 Shore A) CIA 16961***</p> 	<p>CIA 4240</p> 
<p>CIA 4276</p> 	<p>CIA 4176</p> 	<p>CIA 16569** (30 Shore A)</p> 

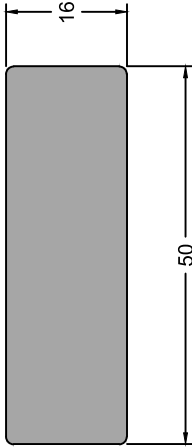
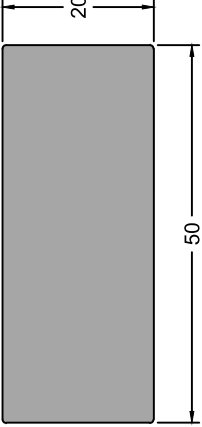
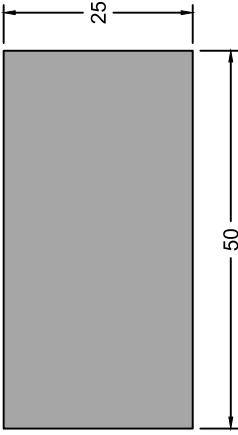
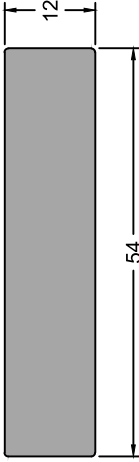
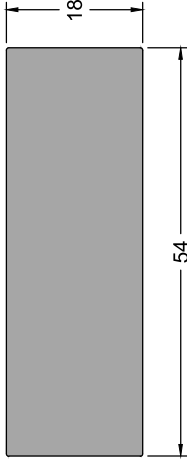
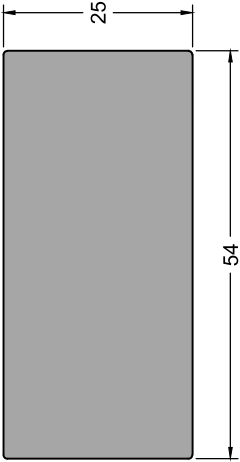
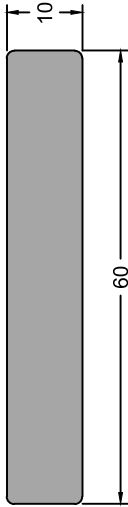
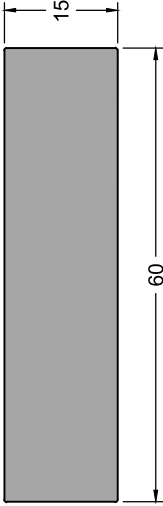
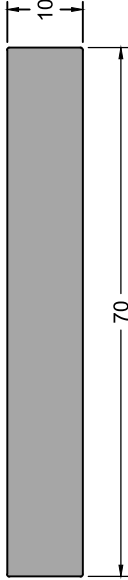
<p>CIA 17202</p> 	<p>CIA 4152</p> 	<p>CIA 4342</p> 
<p>CIA 4040</p> 	<p>CIA 4037 CIA 4076**</p> 	<p>CIA 4082** CIA 4089</p> 
<p>CIA 4289</p> 	<p>CIA 4196</p> 	<p>CIA 4197</p> 

CIA 4214

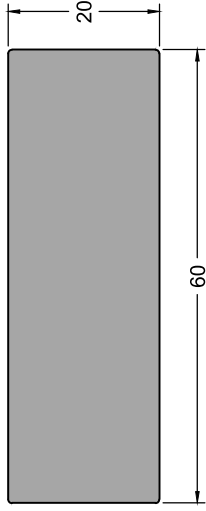

CIA 4119 (15 Shore A)

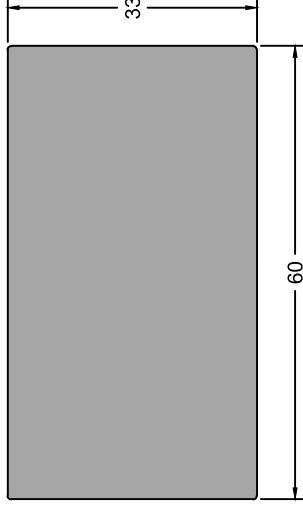

CIA 4182

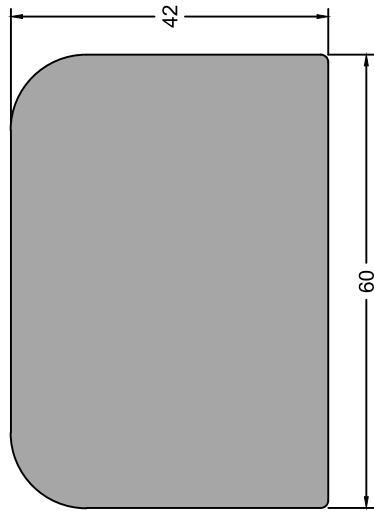

CIA 4142

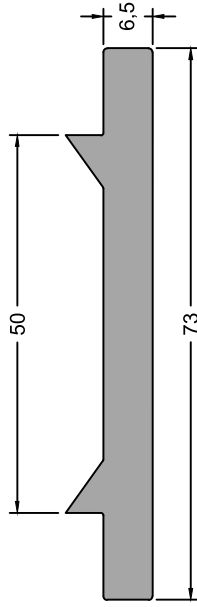

CIA 4198



CIA 4041



CIA 4203 (30 Shore A) ▲

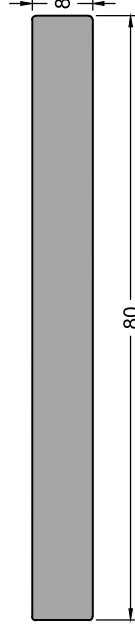

CIA 4344** (15 Shore A)

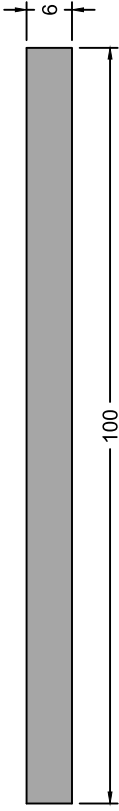

CIA 4147 (15 Shore A)

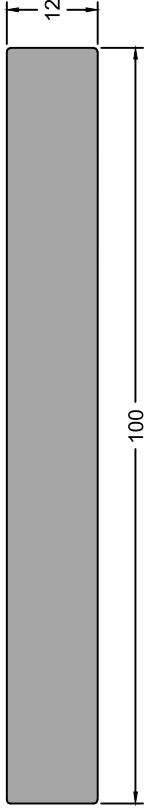

CIA 16591

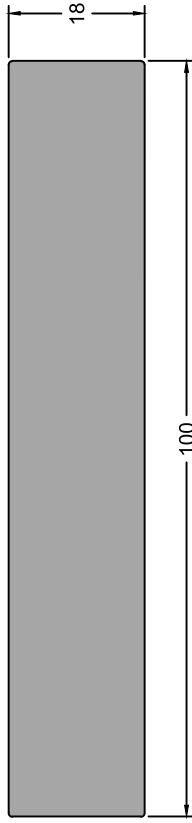

CIA 16992

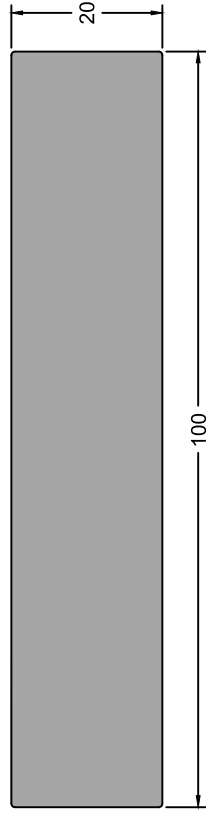

CIA 4359 (15 Shore A)

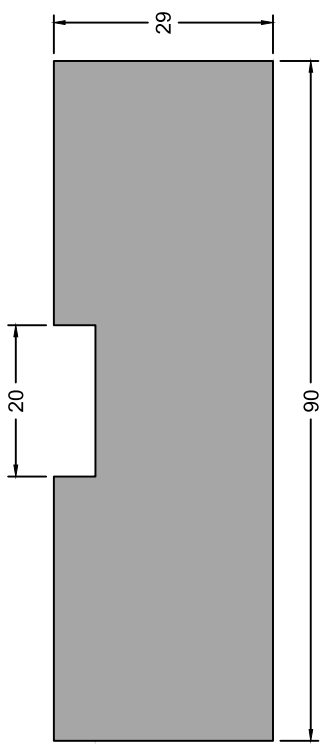

CIA 4287

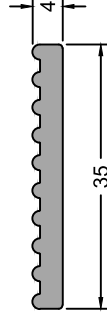

CIA 4265** (15 Shore A)

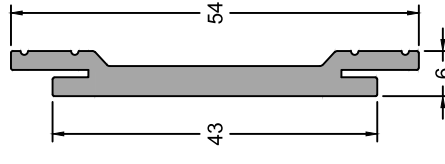

CIA 16081

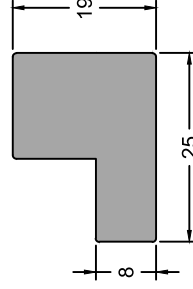

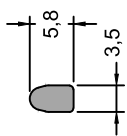
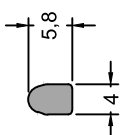
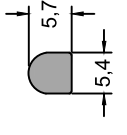
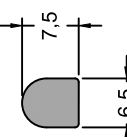
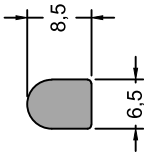
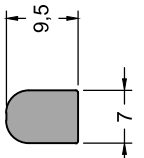
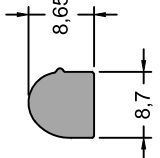
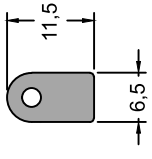
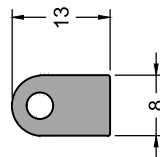
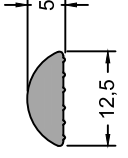
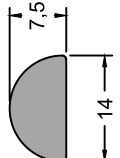
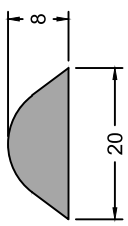
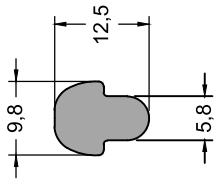
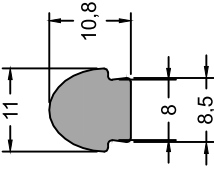
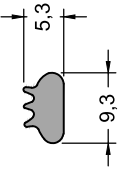
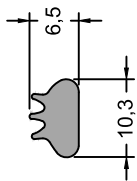
<p>CIA 4247**</p> 	<p>CIA 4248**</p> 	<p>CIA 4156**</p> 	<p>CIA 4253**</p> 
<p>CIA 4262**</p> 	<p>CIA 4163</p> 	<p>CIA 4333** (15Shore A - Cinza)</p> 	<p>CIA 4307 (15 Shore A)</p> 
<p>CIA 4136 (15 Shore A)</p> 	<p>CIA 4245 (30 Shore A)</p> 	<p>CIA 4392** (15 Shore A)</p> 	<p>CIA 4351** (30 Shore A)</p> 
<p>CIA 4215** (15 Shore A)</p> 	<p>CIA 4263</p> 	<p>CIA 4185** (15 Shore A)</p> 	<p>CIA 4184** (15 Shore A)</p> 

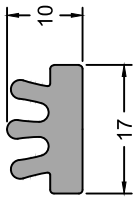
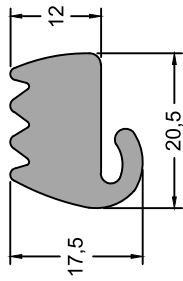
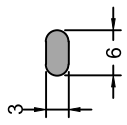
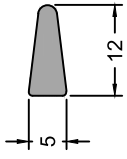
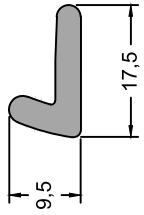
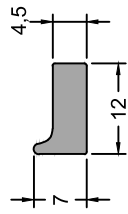
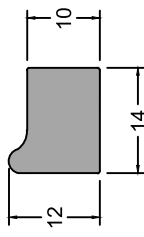
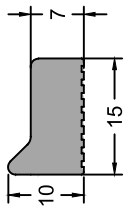
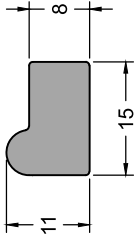
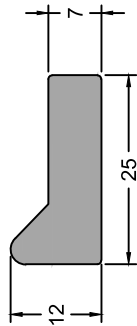
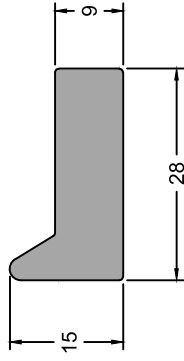
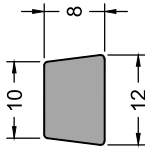
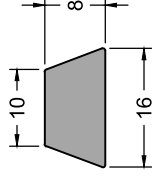
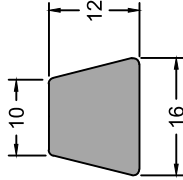
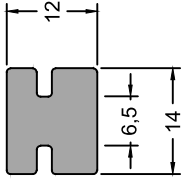
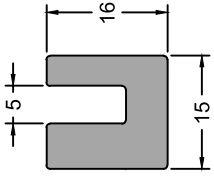
<p>CIA 4241</p> 	<p>CIA 4271**</p> 	<p>CIA 4295 (30 Shore A)</p> 	<p>CIA 4125**</p> 
<p>CIA 4370**(15 Shore A)</p> 	<p>CIA 4134</p> 	<p>CIA 4062</p> 	<p>CIA 4055</p> 
<p>CIA 4193 **</p> 	<p>CIA 16787**</p> 	<p>CIA 4357 (15 Shore A)</p> 	<p>CIA 4168</p> 
<p>CIA 4188</p> 	<p>CIA 4053</p> 	<p>CIA 14251** (15 Shore A)</p> 	<p>CIA 4268 (30 Shore A)</p> 

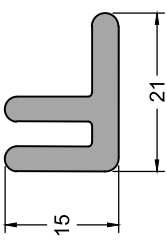
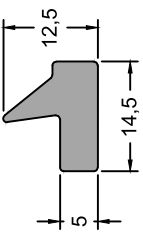
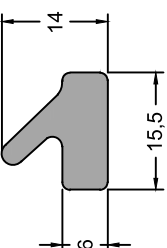
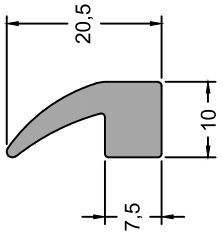
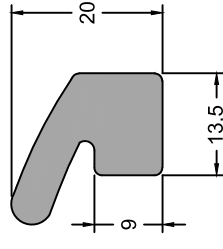
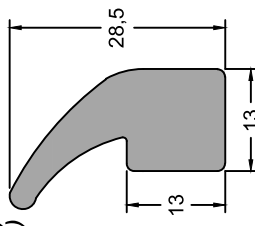
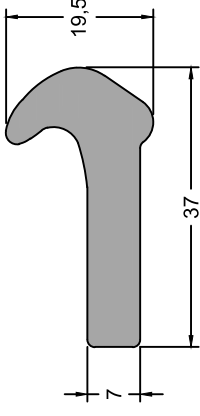
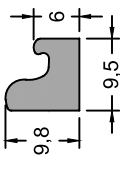
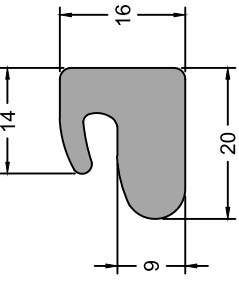
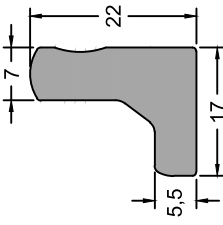
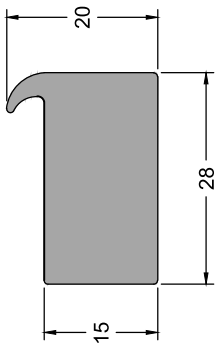
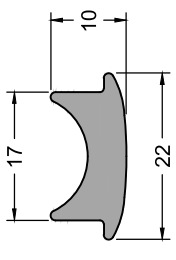
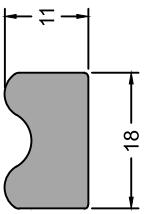
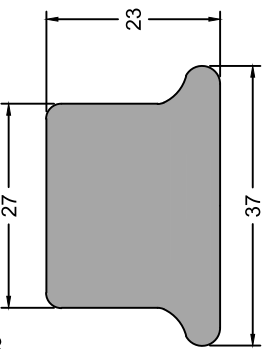
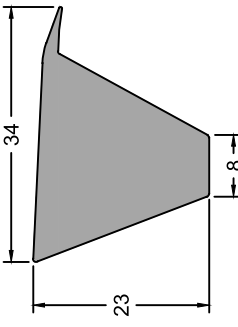
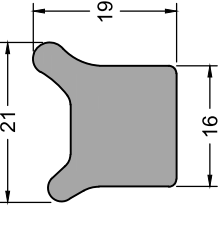
<p>CIA 4153 (15 Shore A)</p> 	<p>CIA 16780**</p> 	<p>CIA 4306**</p> 	<p>CIA 4340** (15 Shore A)</p> 
<p>CIA 14851** (15 Shore A)</p> 	<p>CIA 4175 (15 Shore A) CIA 4339 (30 Shore A)</p> 	<p>CIA 4235**</p> 	<p>CIA 16688**</p> 
<p>CIA 4308</p> 	<p>CIA 16658**</p> 	<p>CIA 4177**</p> 	<p>CIA 4195 (15 Shore A)</p> 
<p>CIA 4054</p> 	<p>CIA 4225</p> 	<p>CIA 4401** (15 Shore A)</p> 	<p>CIA 4111</p> 

CIA 4169

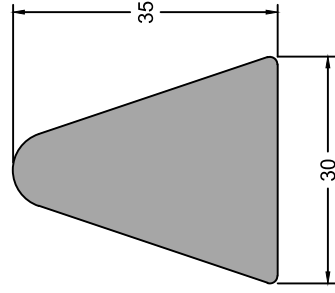

CIA 4226**

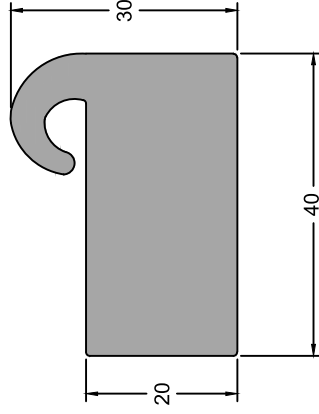

CIA 4160 (15 Shore A)

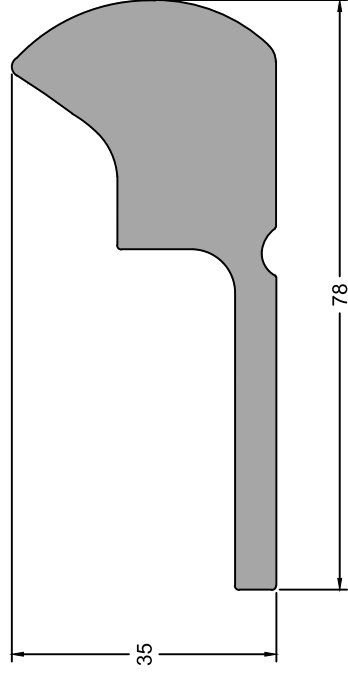

CIA 4110

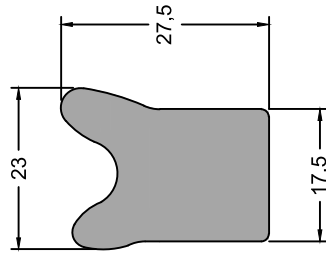

CIA 14320*** (20 Shore A)

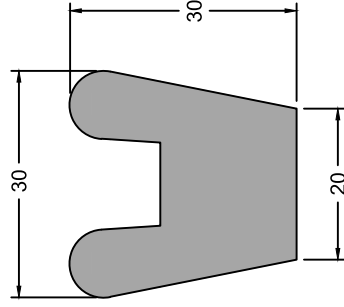

CIA 4251 (15 Shore A)

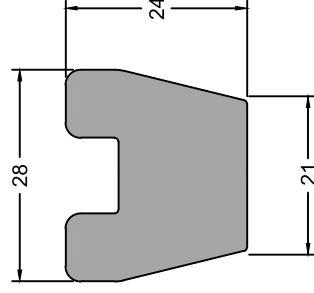

CIA 16677 (15 Shore A)

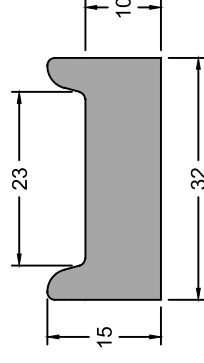

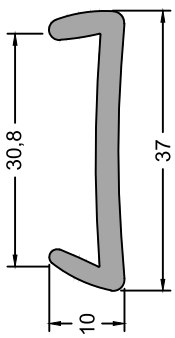
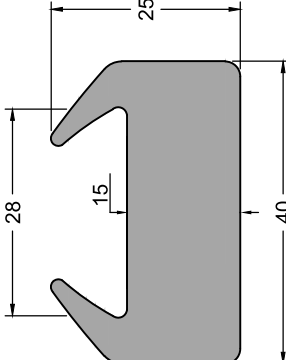
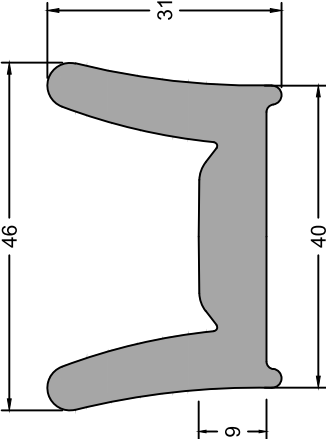
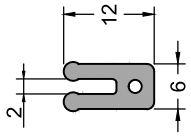
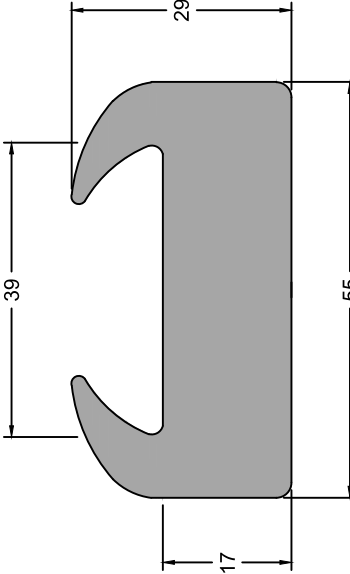
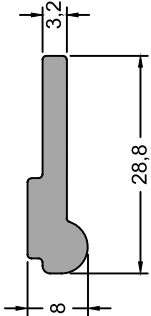
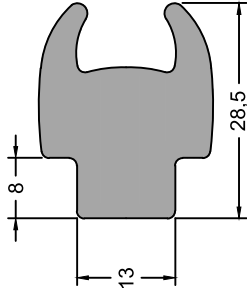
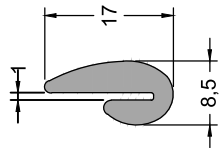
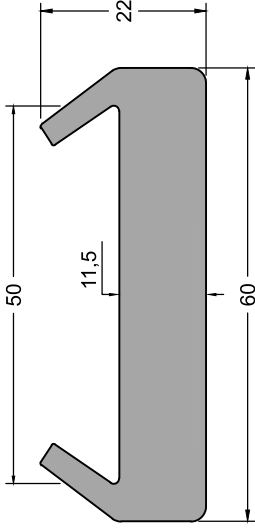
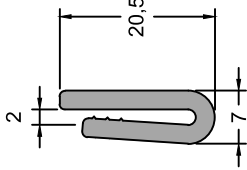
<p>CIA 16998**</p> 	<p>CIA 4216</p> 	<p>CIA 4249 (30 Shore A)</p> 	<p>CIA 4206**</p> 
<p>CIA 4204</p> 	<p>CIA 16964** (15 Shore A)</p> 	<p>CIA 4316** (15 Shore A)</p> 	<p>CIA 4078** (15 Shore A)</p> 
<p>CIA 4219 (15 Shore A)</p> 	<p>CIA 4412** (15 Shore A)</p> 		

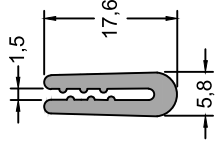
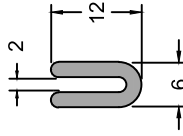
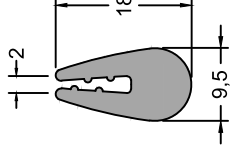
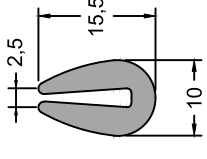
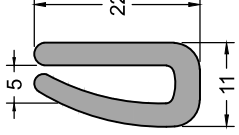
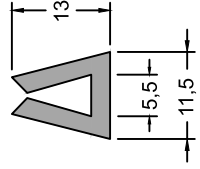
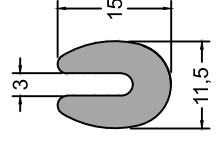
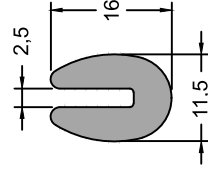
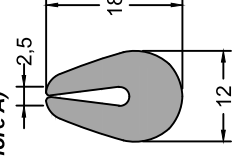
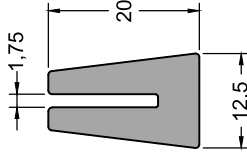
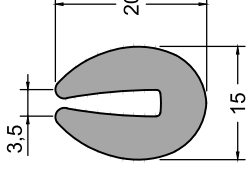
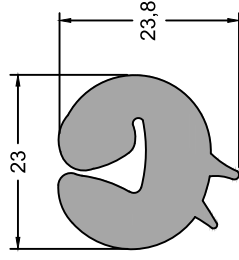
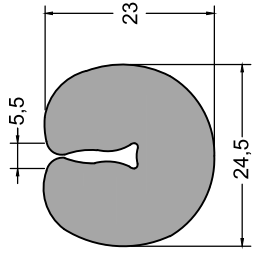
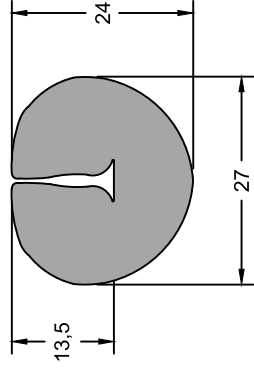
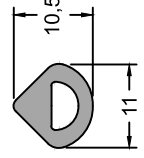
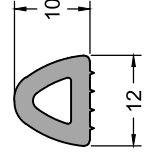
<p>CIA 16741** (15 Shore A)</p> 	<p>CIA 4084** (15 Shore A)</p> 	<p>CIA 4323** (15 Shore A)</p> 	<p>CIA 4238 (15 Shore A)</p> 
<p>CIA 4189** (15 Shore A)</p> 	<p>CIA 4345 (15 Shore A)</p> 	<p>CIA 4157 (15 Shore A)</p> 	<p>CIA 4341** CIA 16866** (15 Shore A)</p> 
<p>CIA 4315 CIA 15937** (15 Shore A)</p> 	<p>CIA 4377 (30 Shore A)</p> 	<p>CIA 4202 (15 Shore A)</p> 	<p>CIA 4158** (15 Shore A)</p> 
<p>CIA 4117</p> 	<p>CIA 4374 (15 Shore A)</p> 	<p>CIA 4310** (Cinza)</p> 	<p>CIA 4052 (30 Shore A) CIA 4332** (15 Shore A - Cinza)</p> 

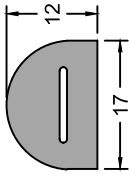
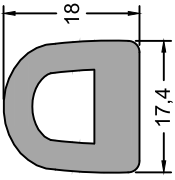
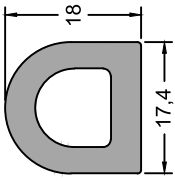
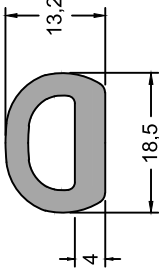
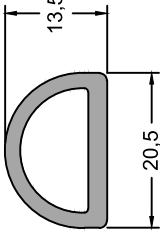
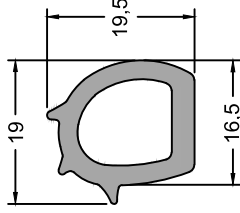
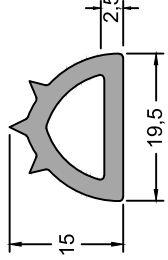
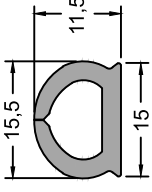
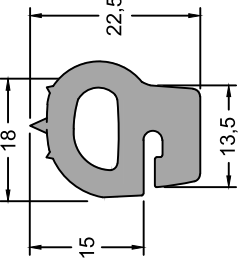
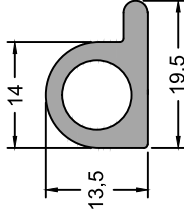
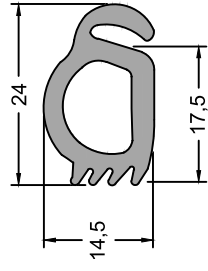
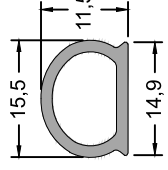
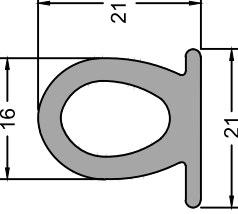
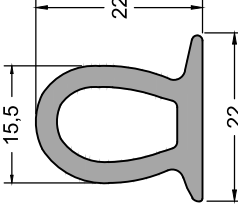
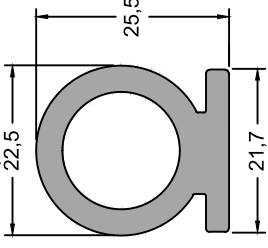
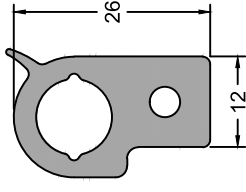
<p>CIA 16665** (15 Shore A)</p> 	<p>CIA 16379** (15 Shore A)</p> 	<p>CIA 17437**</p> 	<p>CIA 4233** (15 Shore A)</p> 
<p>CIA 4286** (15 Shore A)</p> 	<p>CIA 4312** (15 Shore A)</p> 	<p>CIA 4320** (15 Shore A)</p> 	<p>CIA 4199** (20 Shore A)</p> 
<p>CIA 4326** (15 Shore A)</p> 	<p>CIA 4172 (15 Shore A)</p> 	<p>CIA 4057</p> 	<p>CIA 17134** (20 Shore A)</p> 
<p>CIA 4109 (15 Shore A)</p> 	<p>CIA 4116 (15 Shore A)</p> 	<p>CIA 4145** (30 Shore A)</p> 	<p>CIA 4352** (15 Shore A)</p> 

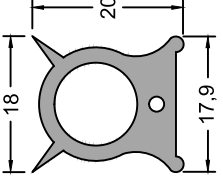
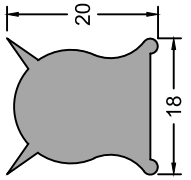
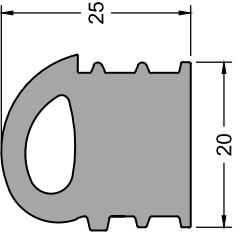
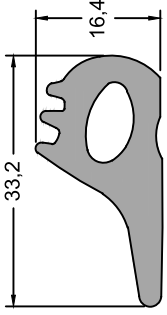
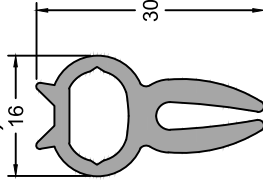
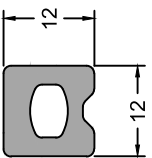
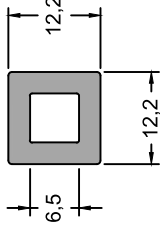
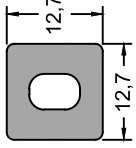
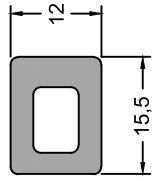
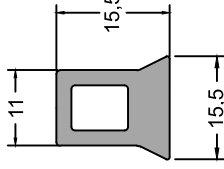
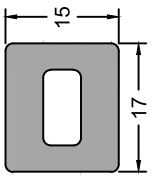
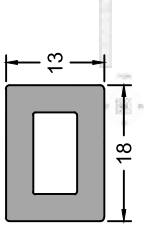
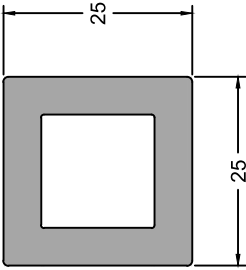
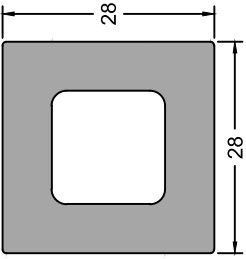
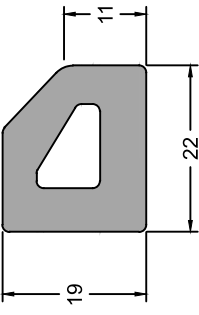
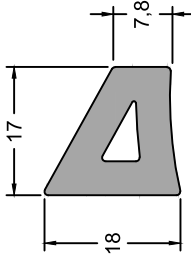
<p>CIA 17246** (30 Shore A)</p> 	<p>CIA 16552** (Shore A)</p> 	<p>CIA 4137**</p> 	<p>CIA 16674** (30 Shore A)</p> 
<p>CIA 4373 (15 Shore A)</p> 	<p>CIA 4258</p> 	<p>CIA 4056</p> 	<p>CIA 16440** (15 Shore A)</p> 
<p>CIA 4303 (15 Shore A)</p> 	<p>CIA 4159 (15 Shore A)</p> 	<p>CIA 4239</p> 	<p>CIA 4067</p> 
<p>CIA 4121** (15 Shore A)</p> 	<p>CIA 16641</p> 	<p>CIA 4113</p> 	<p>CIA 4349** (15 Shore A)</p> 

<p>CIA 15379**</p>	<p>CIA 15895** (15 Shore A)</p>	<p>CIA 4406** (15 Shore A)</p>	<p>CIA 4120**</p>
<p>CIA 4114 (15 Shore A)</p>	<p>CIA 4060</p>	<p>CIA 4348</p>	<p>CIA 4165** (15 Shore A)</p>
<p>CIA 4091</p>	<p>CIA 4366</p>	<p>CIA 4413** (30 Shore A)</p>	<p>CIA 16592</p>
<p>CIA 4139**</p>	<p>CIA 14121** (15 Shore A)</p>	<p>CIA 4212** (15 Shore A)</p>	<p>CIA 15710** (15 Shore A - Cinza)</p>

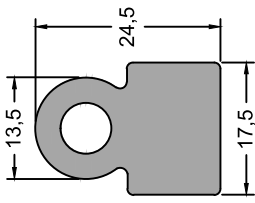
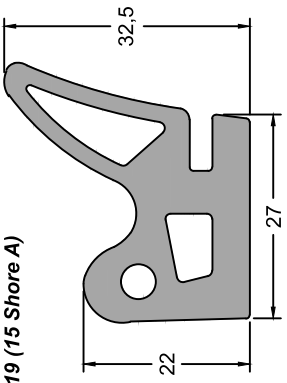
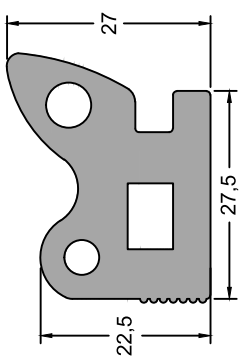
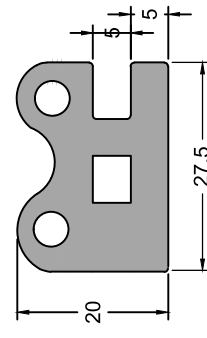
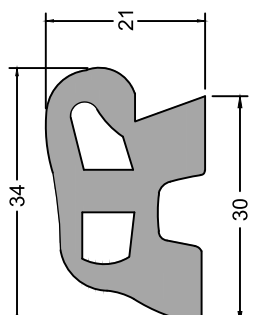
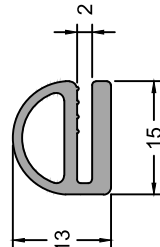
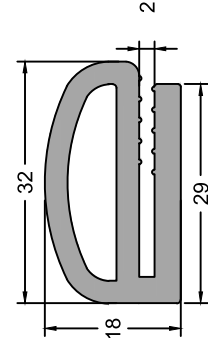
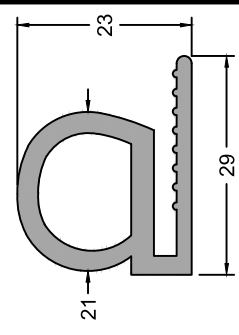
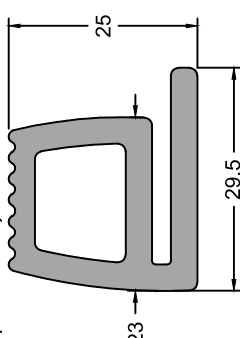
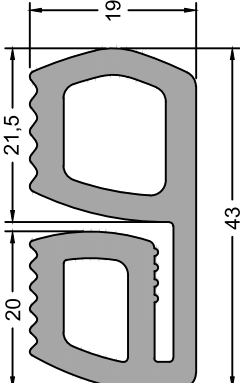
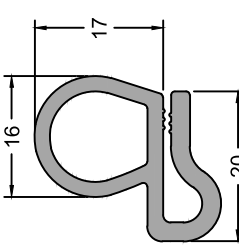
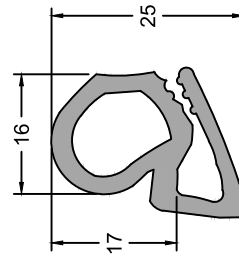
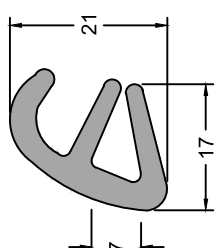
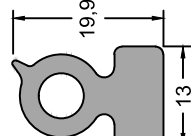
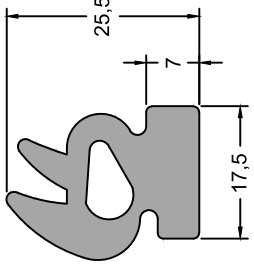
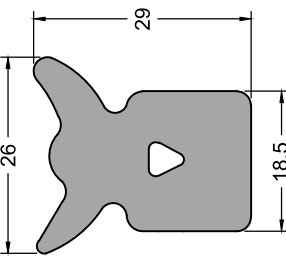
<p>CIA 4093 (15 Shore A)</p> 	<p>CIA 4319 (15 Shore A)</p> 	<p>CIA 16642**</p> 	<p>CIA 4061 (15 Shore A)</p> 
<p>CIA 4115</p> 	<p>CIA 4269 (15 Shore A)</p> 	<p>CIA 17090** (15 Shore A)</p> 	<p>CIA 4336** (15 Shore A Cinza) CIA 17406** (15 Shore A)</p> 
<p>CIA 4066 (15 Shore A) CIA 16825** (15 Shore A)</p> 	<p>CIA 4059 (15 Shore A)</p> 	<p>CIA 4058** (15 Shore A)</p> 	<p>CIA 4391** (15 Shore A)</p> 
<p>CIA 4396** (15 Shore A)</p> 	<p>CIA 16601** (20 Shore A)</p> 	<p>CIA 4376** (15 Shore A)</p> 	<p>CIA 4112**</p> 

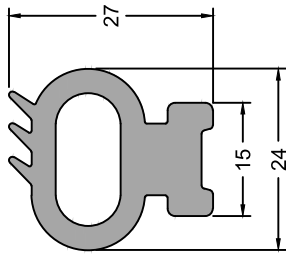
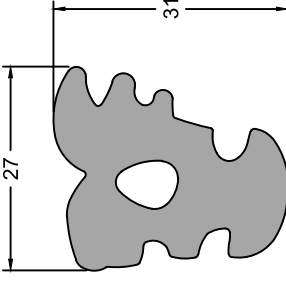
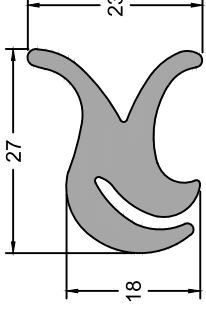
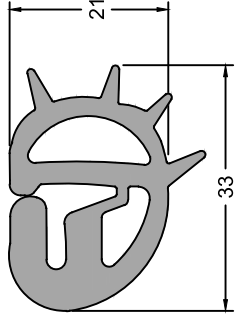
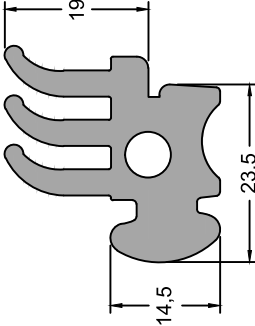
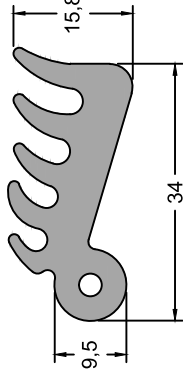
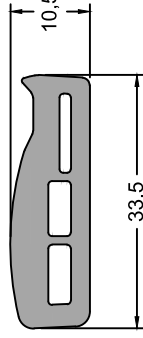
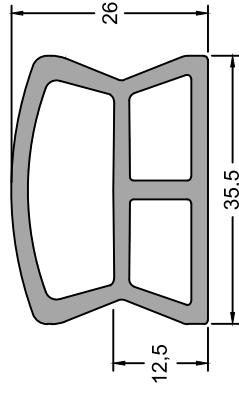
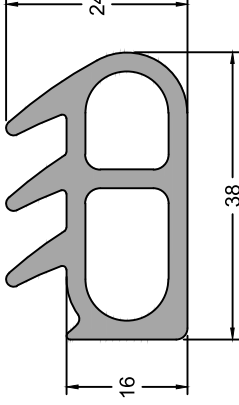
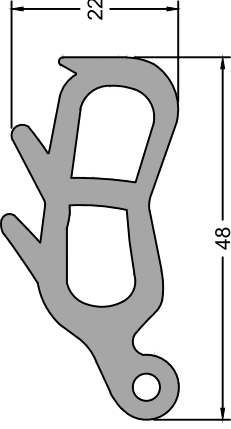
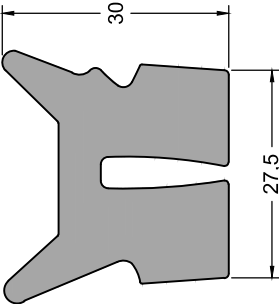
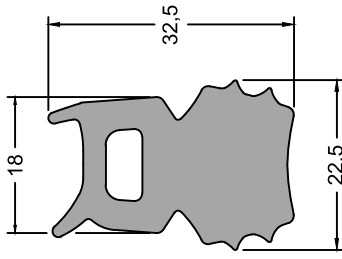
<p>CIA 4304** (15 Shore A)</p> 	<p>CIA 4173**</p> 	<p>CIA 4305 (30 Shore A)</p> 	<p>CIA 4355 (30 Shore A)</p> 
<p>CIA 4375** (15 Shore A)</p> 	<p>CIA 4380** (30 Shore A)</p> 	<p>CIA 4372** (30 Shore A)</p> 	<p>CIA 4360** (15 Shore A)</p> 
<p>CIA 4369** (30 Shore A)</p> 	<p>CIA 4368** (30 Shore A)</p> 	<p>CIA 4133 (15 Shore A)</p> 	<p>CIA 4301**</p> 

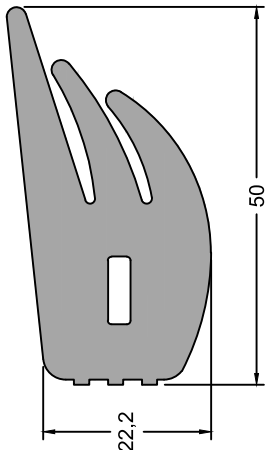
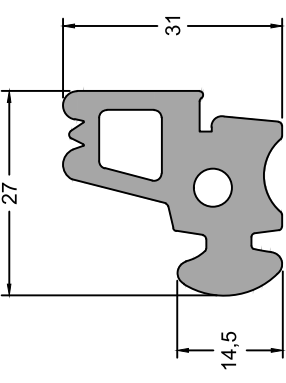
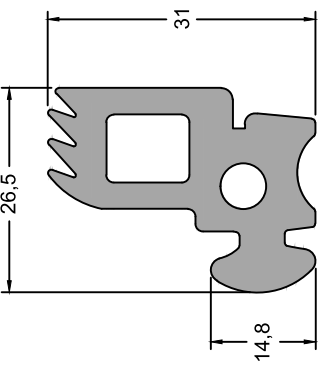
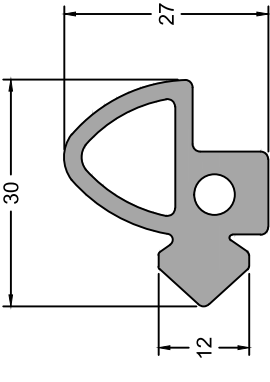
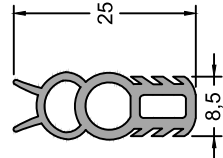
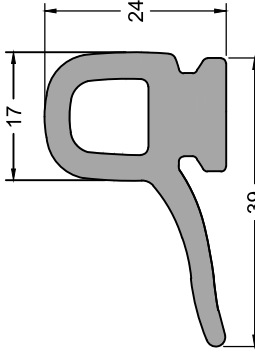
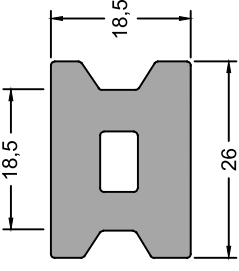
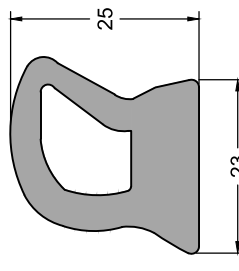
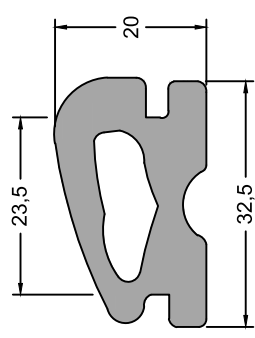
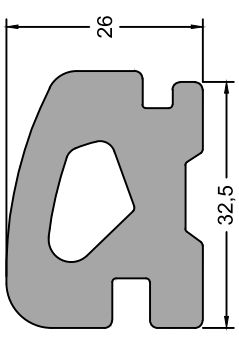
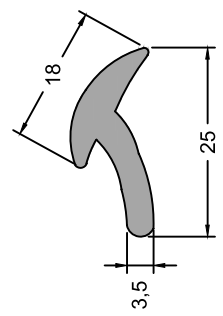
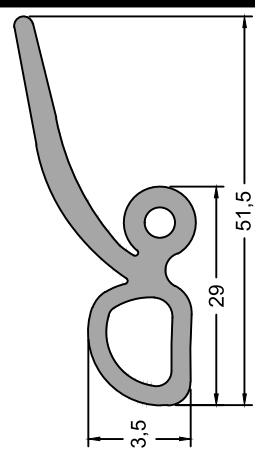
<p>CIA 4379** (15 Shore A)</p> 	<p>CIA 4313** (15 Shore A)</p> 	<p>CIA 4309** (15 Shore A)</p> 	<p>CIA 4270** (15 Shore A)</p> 
<p>CIA 16604** (30 Shore A)</p> 	<p>CIA 4190**</p> 	<p>CIA 14534</p> 	<p>CIA 4123** (15 Shore A)</p> 
<p>CIA 14537</p> 	<p>CIA 4092</p> 	<p>CIA 14229** (15 Shore A)</p> 	<p>CIA 4365** (30 Shore A)</p> 

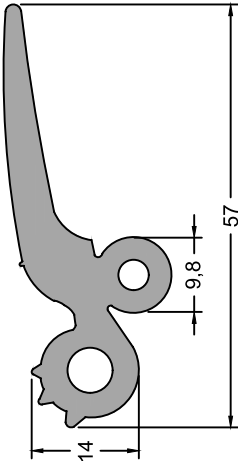
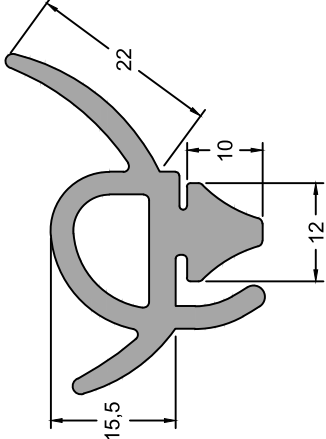
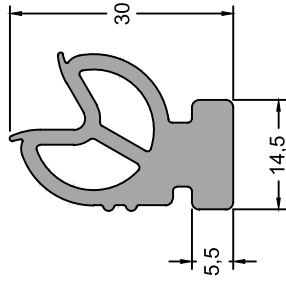
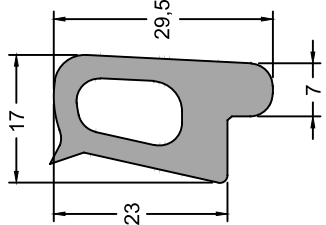
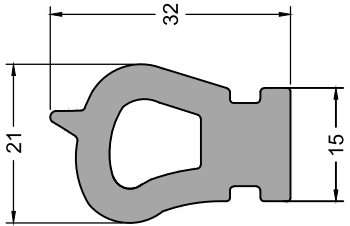
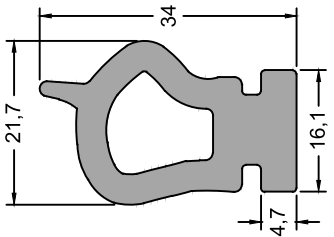
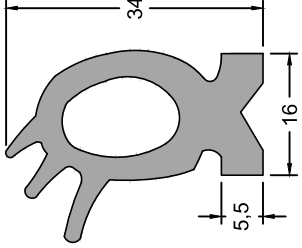
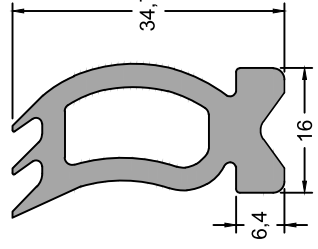
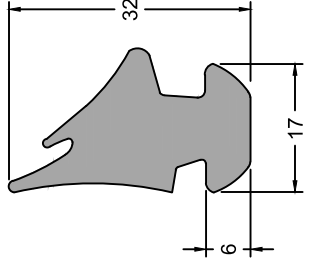
<p>CIA 4367** (15 Shore A)</p> 	<p>CIA 4318** (15 Shore A)</p> 	<p>CIA 4394** (15 Shore A)</p> 
<p>CIA 4386** (15 Shore A)</p> 	<p>CIA 4174**</p> 	<p>CIA 16958** (15 Shore A)</p> 
<p>CIA 4393** (15 Shore A)</p> 	<p>CIA 16868** (20 Shore A)</p> 	<p>CIA 4314**</p> 

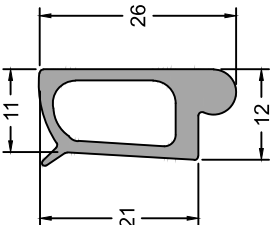
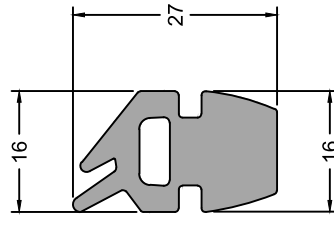
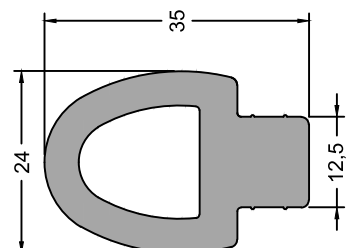
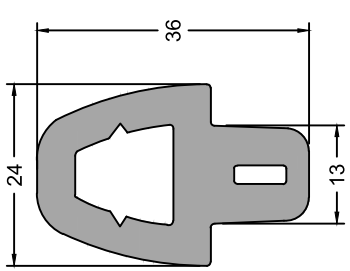
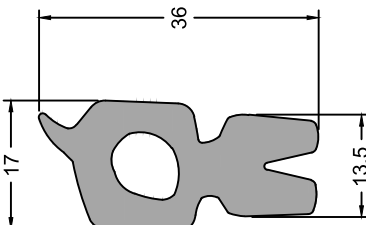
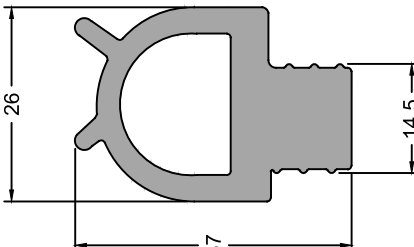
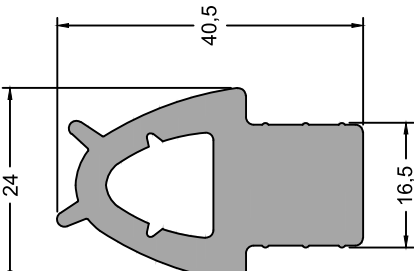
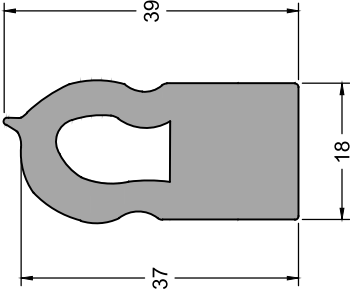
<p>CIA 4354** (25 Shore A)</p> 	<p>CIA 15024** (15 Shore A)</p> 	<p>CIA 4296** (15 Shore A)</p> 	<p>CIA 4407** (15 Shore A)</p> 
<p>CIA 4223** (15 Shore A)</p> 	<p>CIA 4256** (10 Shore A)</p> 	<p>CIA 4217** (15 Shore A)</p> 	<p>CIA 4131** CIA 15811**</p> 

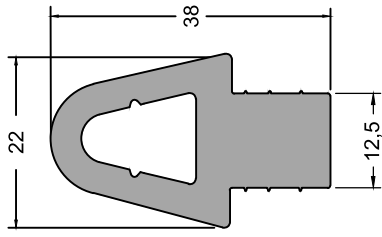
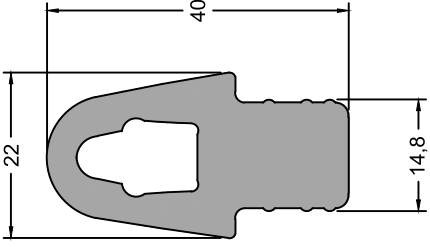
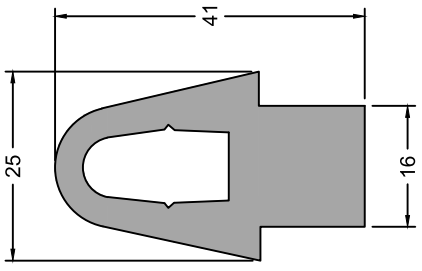
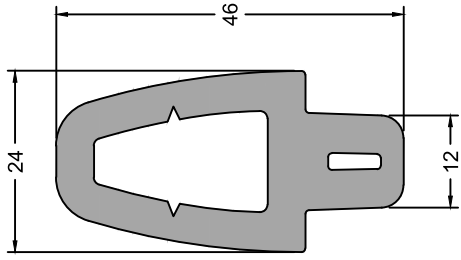
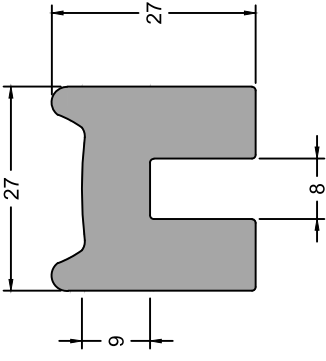
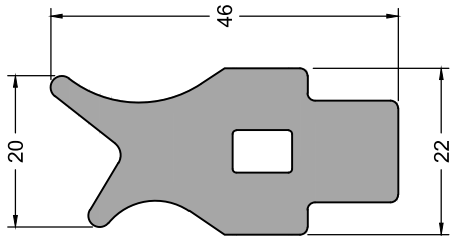
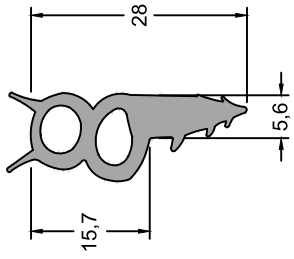
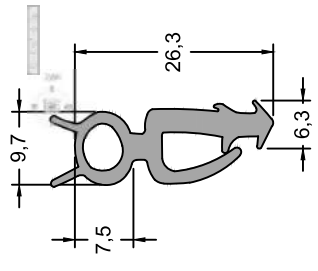
<p>CIA 4071** (15 Shore A)</p> 	<p>CIA 15006** (15 Shore A)</p> 	<p>CIA 4400** (15 Shore A)</p> 	<p>CIA 4346** (30 Shore A)</p> 
<p>CIA 15020 (15 Shore A)</p> 	<p>CIA 4179**</p> 	<p>CIA 15457** (30 Shore A)</p> 	<p>CIA 15456** (30 Shore A)</p> 

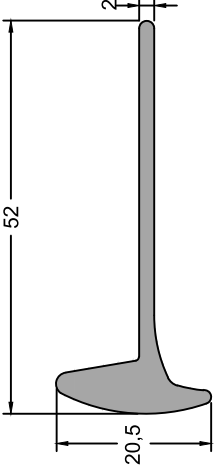
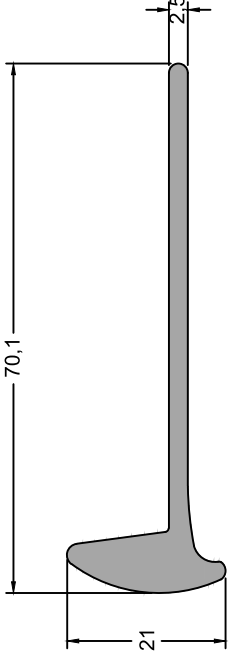
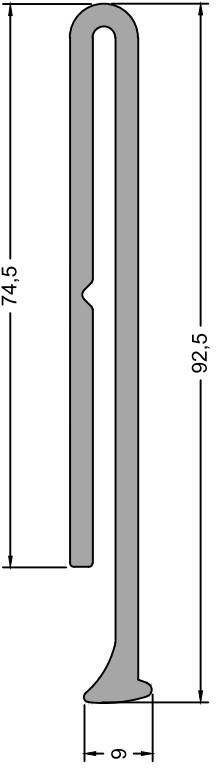
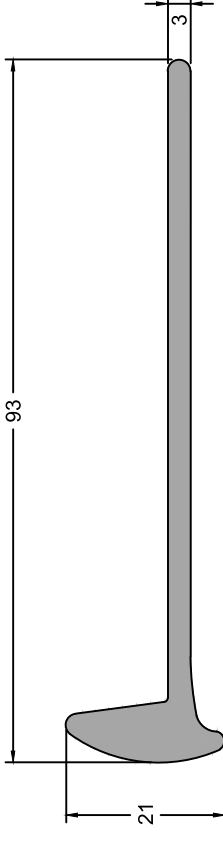
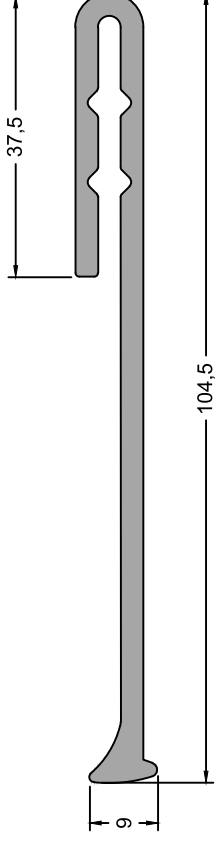
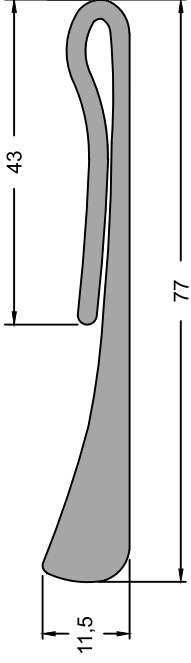
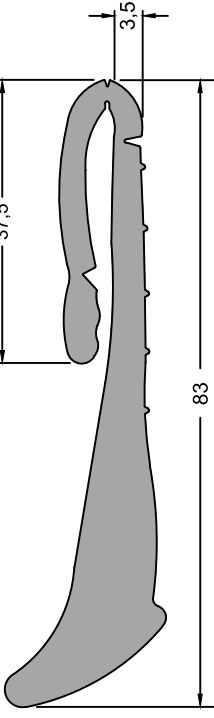
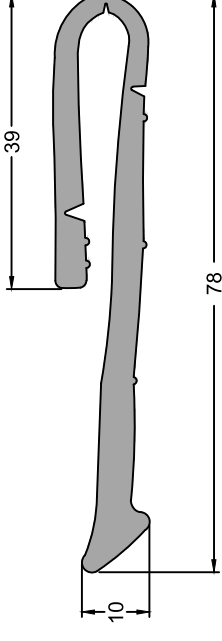
<p>CIA 4291**</p> 	<p>CIA 4292**</p> 
<p>CIA 4284**</p> 	<p>CIA 4293**</p> 
<p>CIA 4283**</p> 	<p>CIA 4161**</p> 
<p>CIA 4086** (25 Shore A)</p> 	<p>CIA 4088** (25 Shore A)</p> 

CIA 4166**

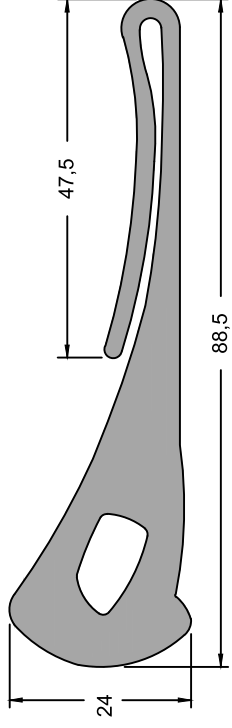

CIA 4090 (25 Shore A)**

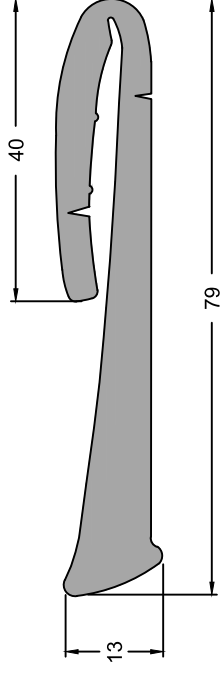

CIA 4274**

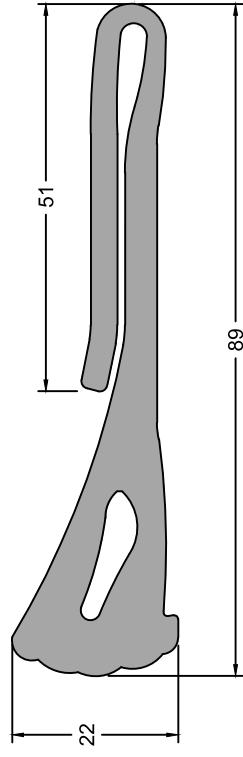

CIA 4085 (25 Shore A)**

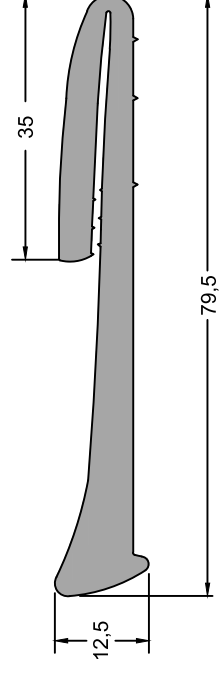

CIA 4148 (25 Shore A)**

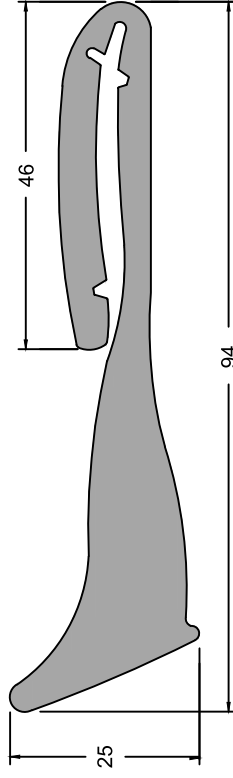

CIA 4294**

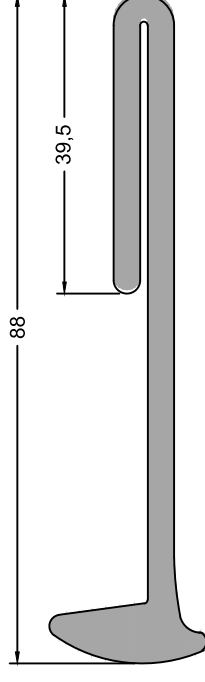



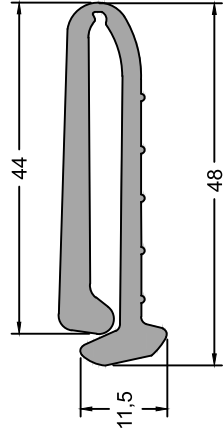



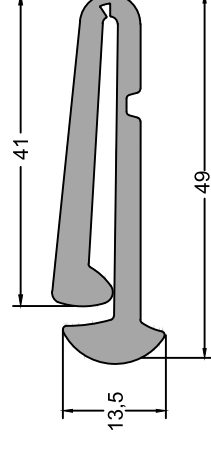

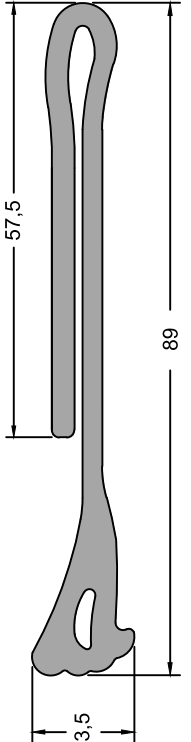
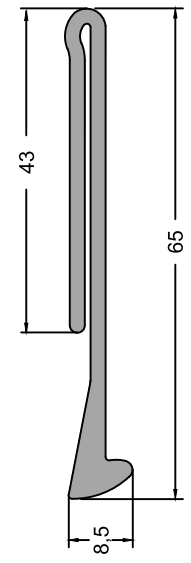
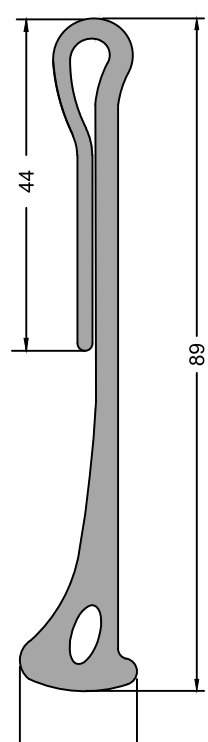
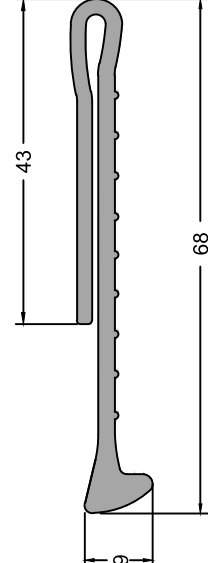
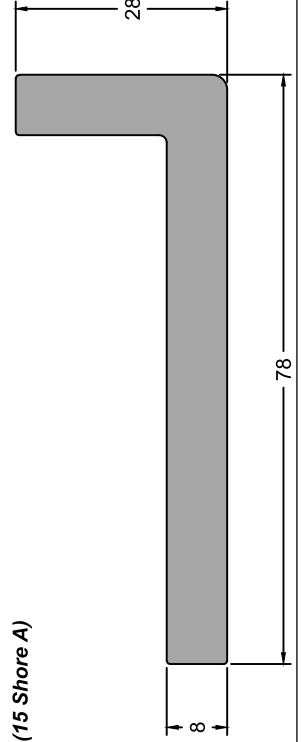

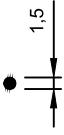
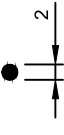
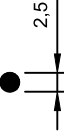
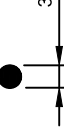
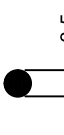

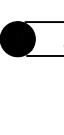
CIA 4275 (25 Shore A)**









CIA 4138 (25 Shore A)**

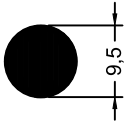

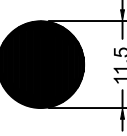



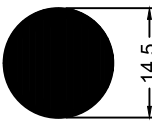
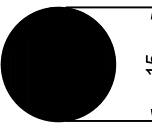
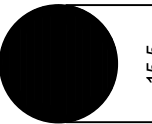
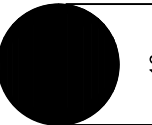
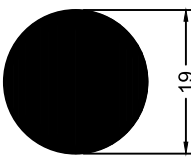
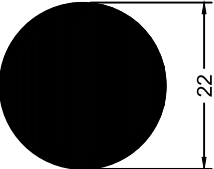
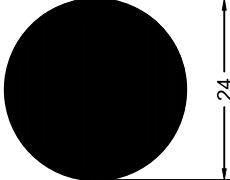
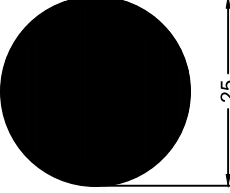



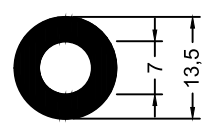
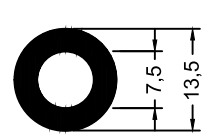
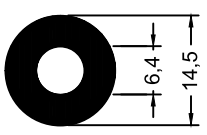
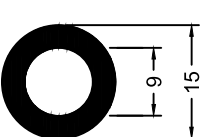

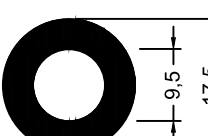
<p>CIA 4272**</p> 	<p>CIA 4177**</p> 
<p>CIA 4178**</p> 	<p>CIA 4273**</p> 
<p>CIA 4356 (15 Shore A)</p> 	

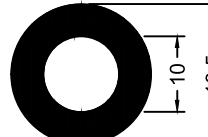
CIA 6147*** 	CIA 6146*** 	CIA 6007*** CIA 6304** 	CIA 6272** CIA 6002*** 
CIA 6003*** CIA 6212** CIA 7071 # 	CIA 6004*** CIA 6211** 	CIA 6005*** 	CIA 6006*** CIA 6496 CIA 7013 # 
CIA 6007*** 	CIA 6008*** CIA 16559 	CIA 6138*** 	CIA 6010*** 
CIA 6503*** 	CIA 6011*** 	CIA 6139*** 	CIA 6009*** 

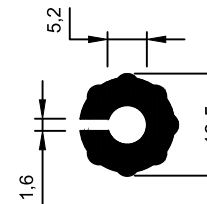
CIA 6049*** 	CIA 6085*** 	CIA 6013*** 	CIA 6140*** 
CIA 6012*** 	CIA 6014*** 	CIA 6015*** 	CIA 6384*** 
CIA 14917*** 	CIA 6016*** 	CIA 6017*** 	CIA 6064*** CIA 6497 
CIA 6141*** 	CIA 6336*** CIA 6467 	CIA 6431 CIA 16566 	CIA 6164*** 

<p>CIA 6494 CIA 6510**</p>	<p>CIA 6156** CIA 6350***▲</p>	<p>CIA 16032**</p>	<p>CIA 16590</p>
<p>CIA 6461** CIA 16462</p>	<p>CIA 6433**</p>	<p>CIA 6154*▲ CIA 16464</p>	<p>CIA 6056**</p>
<p>CIA 17095</p>	<p>CIA 6047***</p>	<p>CIA 6097*** CIA 6347**</p>	<p>CIA 6062*** CIA 16428</p>
<p>CIA 6358**</p>	<p>CIA 6018**</p>	<p>CIA 6187**</p>	<p>CIA 6022**</p>

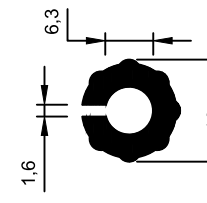
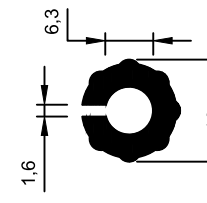
<p>CIA 6356</p> 	<p>CIA 6201** CIA 16463</p> 	<p>CIA 6019</p> 	<p>CIA 6109***</p> 
<p>CIA 6321**</p> 	<p>CIA 6269**</p> 	<p>CIA 14555***</p> 	<p>CIA 16668</p> 
<p>CIA 6065</p> 	<p>CIA 16628</p> 	<p>CIA 9162**</p> 	<p>CIA 6388</p> 
<p>CIA 6021</p> 	<p>CIA 7055 #</p> 	<p>CIA 14383**</p> 	<p>CIA 14383**</p> 

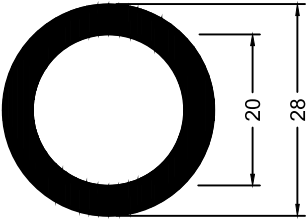
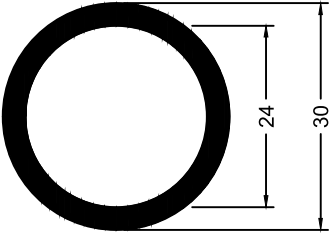
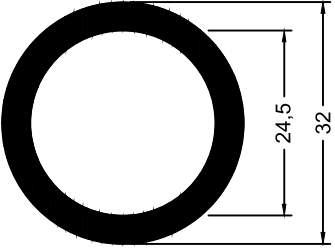
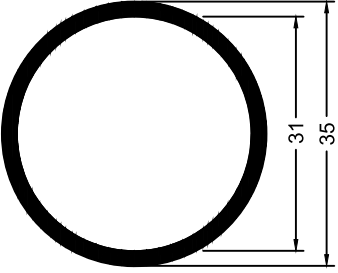
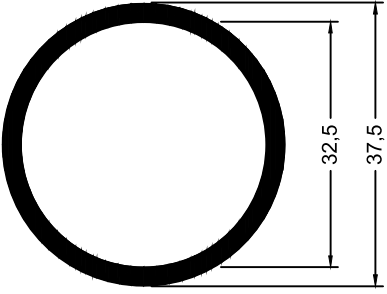
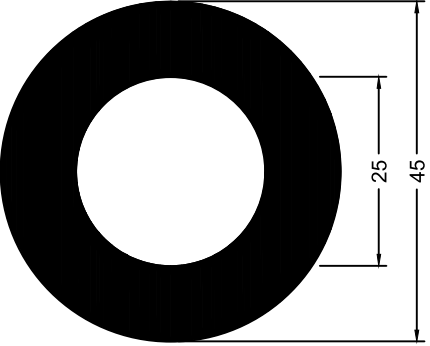
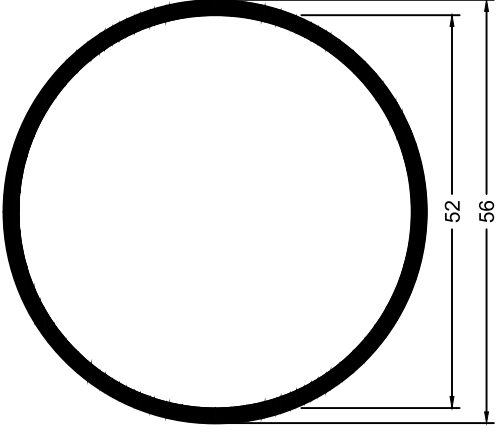

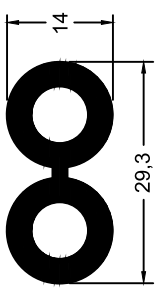
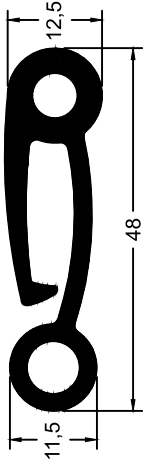
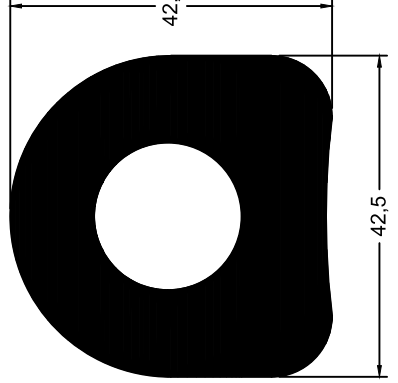
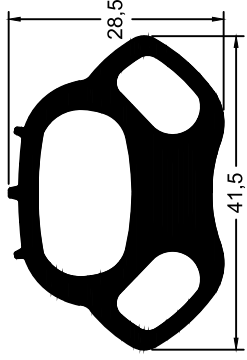
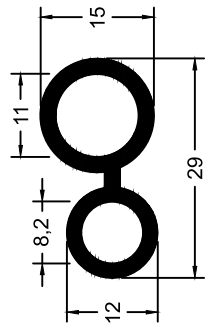
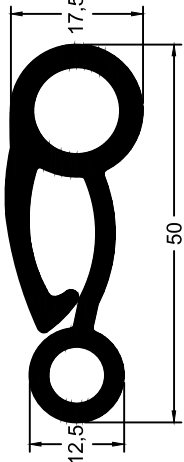
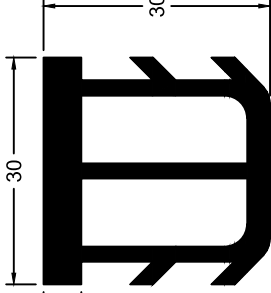
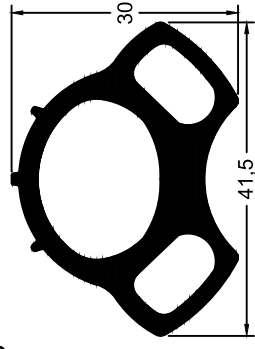
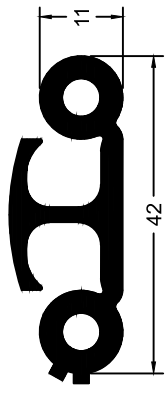
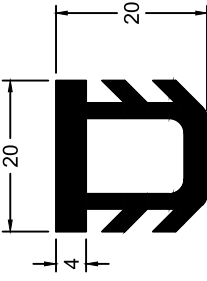
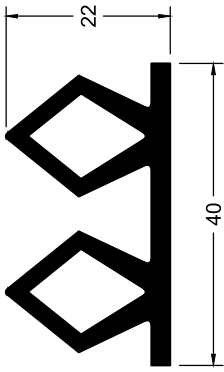
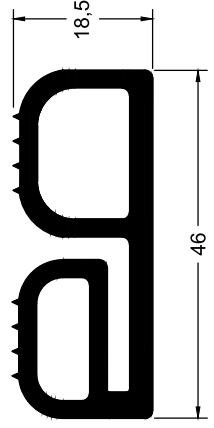
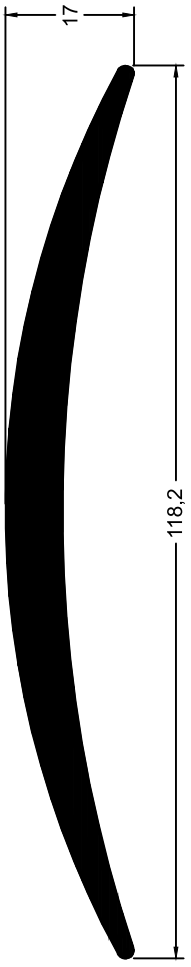

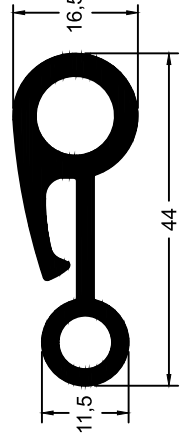
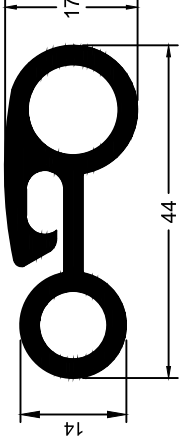
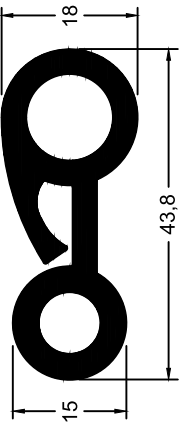
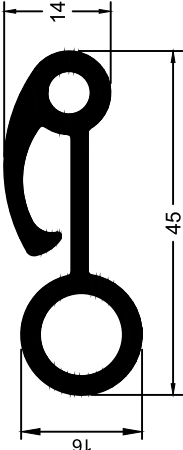
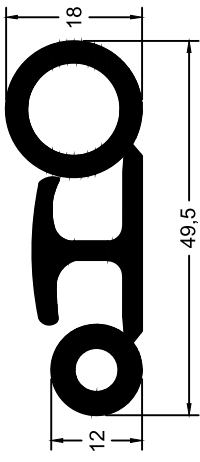
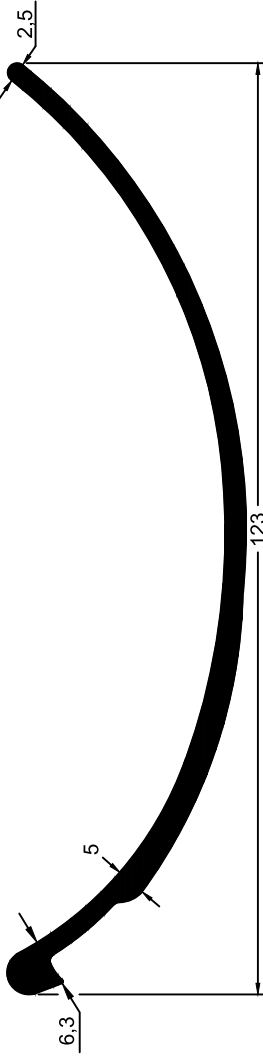
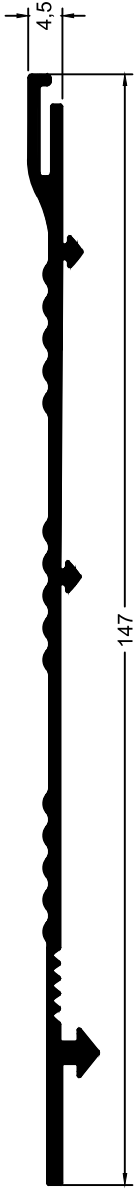
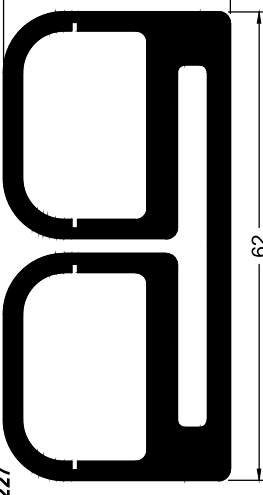
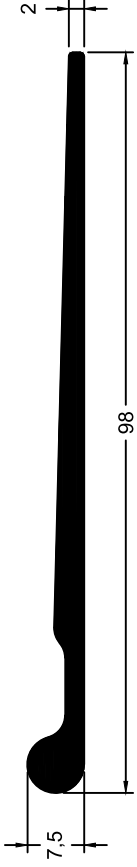
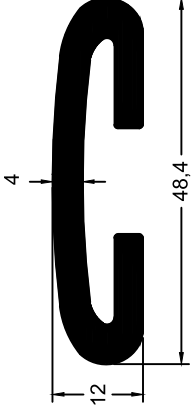

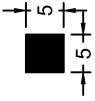
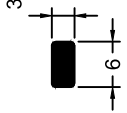
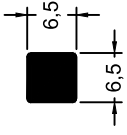
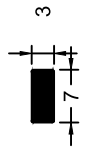
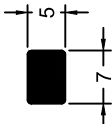
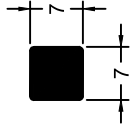
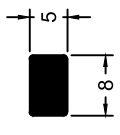
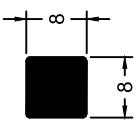
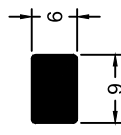
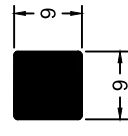
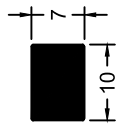
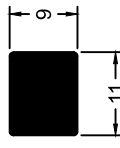
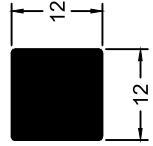
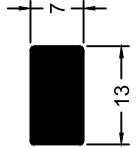
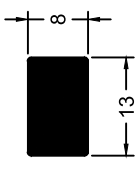
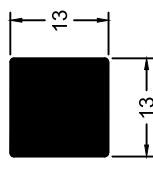
<p>CIA 6202**</p>  <p>20 28</p>	<p>CIA 16198#</p>  <p>24 30</p>	<p>CIA 17258***</p>  <p>24,5 32</p>	<p>CIA 16249#</p>  <p>31 35</p>
<p>CIA 6119</p>  <p>32,5 37,5</p>	<p>CIA 14554***</p>  <p>25 45</p>	<p>CIA 16329#</p>  <p>52 56</p>	

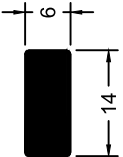
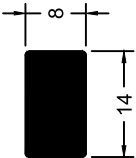
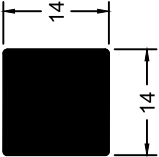
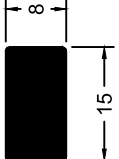
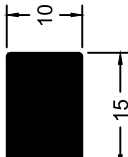
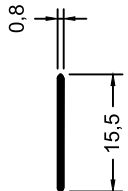
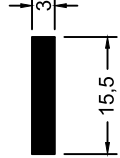
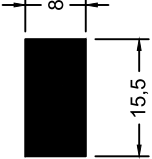
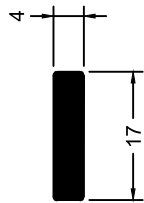
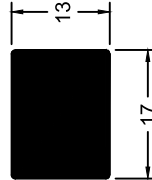
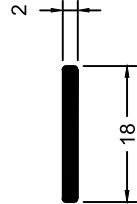
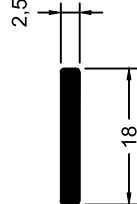
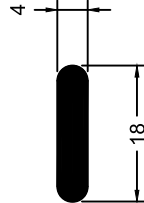
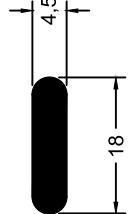
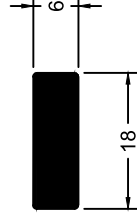
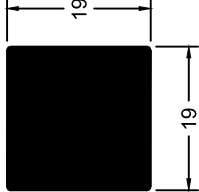

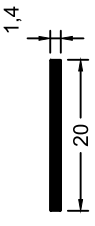
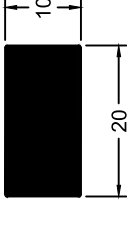
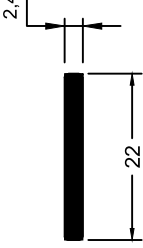
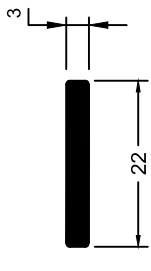
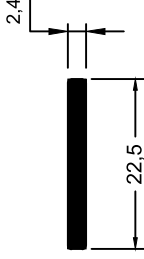
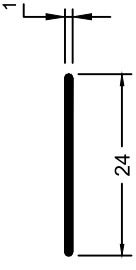
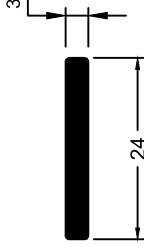

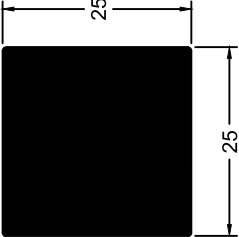
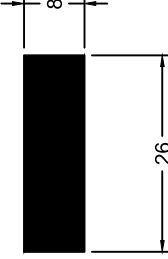

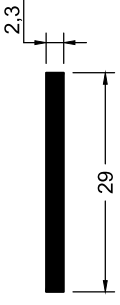
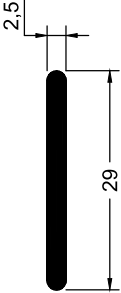
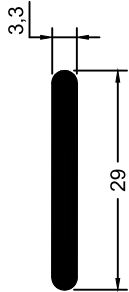

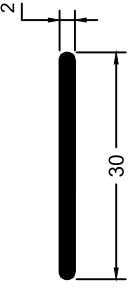
<p>CIA 6020**</p>  <p>Dimensions: 14 (width), 29,3 (height)</p>	<p>CIA 6330**</p>  <p>Dimensions: 11,5 (width), 12,5 (width), 48 (height)</p>	<p>CIA 17011</p>  <p>Dimensions: 42,6 (width), 42,5 (height)</p>	<p>CIA 6387</p>  <p>Dimensions: 28,5 (width), 41,5 (height)</p>
<p>CIA 15883</p>  <p>Dimensions: 8,2 (width), 11 (width), 15 (width), 29 (height)</p>	<p>CIA 6295**</p>  <p>Dimensions: 12,5 (width), 17,5 (width), 50 (height)</p>	<p>CIA 6414**</p>  <p>Dimensions: 5 (width), 30 (width), 30 (height)</p>	<p>CIA 6386</p>  <p>Dimensions: 30 (width), 41,5 (height)</p>
<p>CIA 6234**</p>  <p>Dimensions: 11 (width), 42 (height)</p>	<p>CIA 6415**</p>  <p>Dimensions: 4 (width), 20 (width), 20 (height)</p>	<p>CIA 6222</p>  <p>Dimensions: 22 (width), 40 (height)</p>	<p>CIA 6079**</p>  <p>Dimensions: 18,5 (width), 46 (height)</p>
<p>CIA 14579 #)</p>  <p>Dimensions: 118,2 (width), 17 (height)</p>			

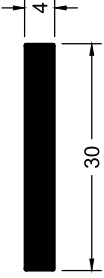

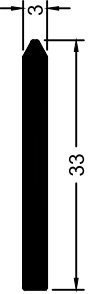
<p>CIA 6148**</p>  <p>Dimensions: 11,5, 16,5, 44</p>	<p>CIA 6504**</p>  <p>Dimensions: 17, 44</p>	<p>CIA 6098**</p>  <p>Dimensions: 15, 18, 43,8</p>	<p>CIA 6334**</p>  <p>Dimensions: 16, 14, 45</p>
<p>CIA 6188**</p>  <p>Dimensions: 12, 18, 49,5</p>	<p>CIA 7026#</p>  <p>Dimensions: 6,3, 5, 123</p>	<p>CIA 7074 #</p>  <p>Dimensions: 4,5, 147</p>	
<p>CIA 6227</p>  <p>Dimensions: 30, 62</p>	<p>CIA 6316**</p>  <p>Dimensions: 7,5, 2, 98</p>		
<p>CIA 16000</p>  <p>Dimensions: 4, 12, 48,4</p>			

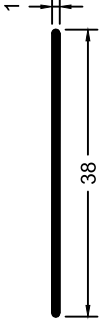
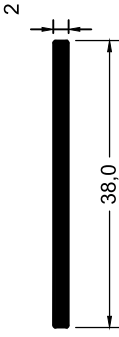
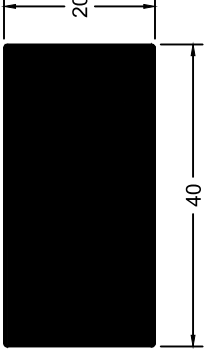
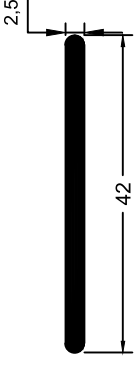
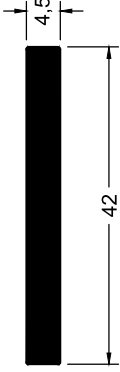

<p>CIA 16750</p> 	<p>CIA 6479**</p> 	<p>CIA 6324***</p> 	<p>CIA 17063</p> 
<p>CIA 6495**</p> 	<p>CIA 6471** CIA 16751</p> 	<p>CIA 6311***</p> 	<p>CIA 6083*** CIA 14037**</p> 
<p>CIA 6458**</p> 	<p>CIA 6086***</p> 	<p>CIA 16770</p> 	<p>CIA 6425***</p> 
<p>CIA 6053***</p> 	<p>CIA 6071***</p> 	<p>CIA 6135***</p> 	<p>CIA 6070***</p> 

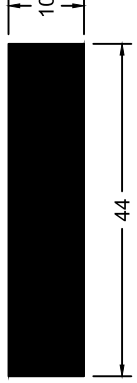
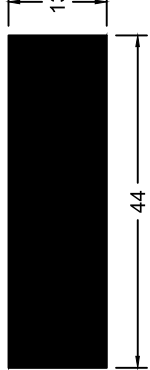
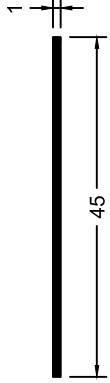
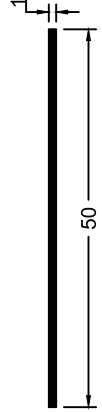

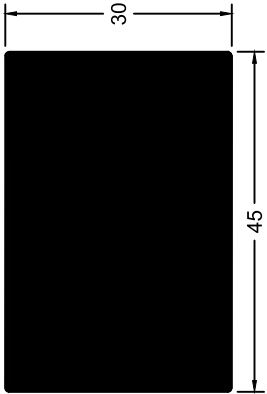
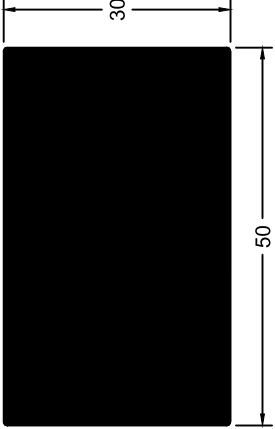
<p>CIA 6136***</p> 	<p>CIA 6107***</p> 	<p>CIA 6367**</p> 	<p>CIA 6474**</p> 
<p>CIA 6473</p> 	<p>CIA 6486**</p> 	<p>CIA 16010</p> 	<p>CIA 16011</p> 
<p>CIA 6449**</p> 	<p>CIA 6325</p> 	<p>CIA 6260***</p> 	<p>CIA 6274***</p> 
<p>CIA 6259**</p> 	<p>CIA 6297***</p> 	<p>CIA 6159***</p> 	<p>CIA 6379</p> 

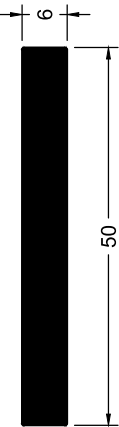
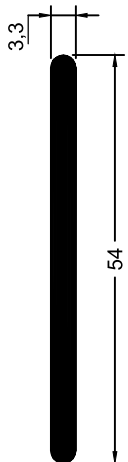
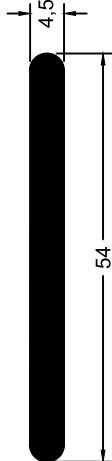
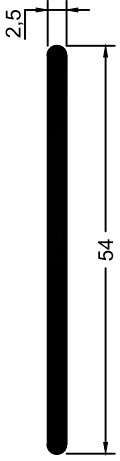
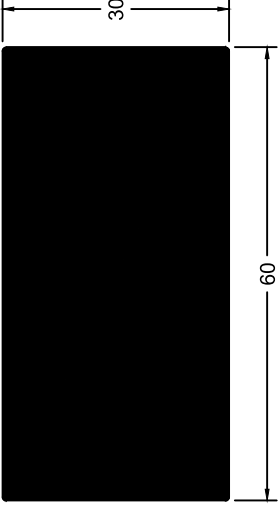
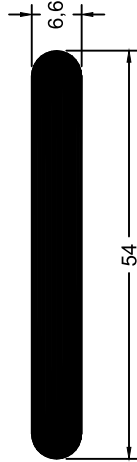
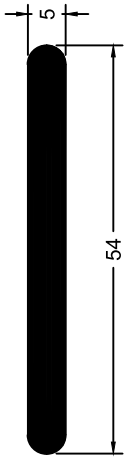
<p>CIA 17433</p> 	<p>CIA 14360**</p> 	<p>CIA 6229</p> 	<p>CIA 6466**</p> 
<p>CIA 6464**</p> 	<p>CIA 6193**</p> 	<p>CIA 6477**</p> 	<p>CIA 6023**</p> 
<p>CIA 6395*** CIA 16118**</p> 	<p>CIA 16012</p> 	<p>CIA 6205***</p> 	<p>CIA 6218</p> 
<p>CIA 6263***</p> 	<p>CIA 6275***</p> 	<p>CIA 6262***</p> 	<p>CIA 7064 #</p> 

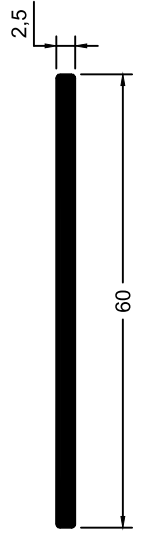
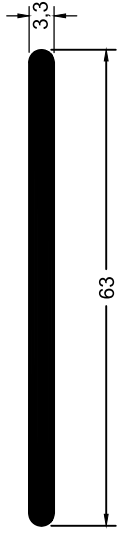

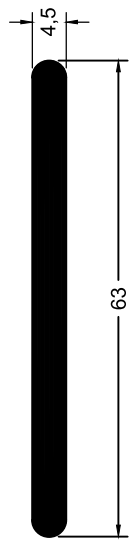
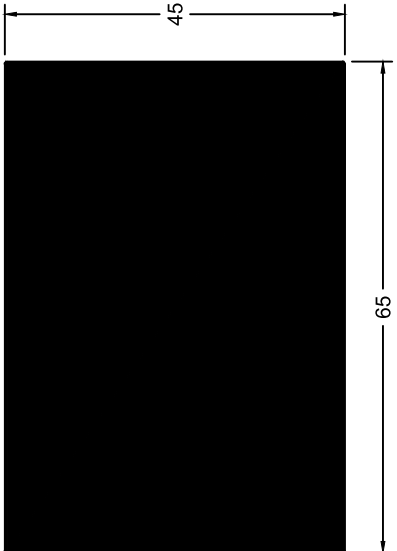
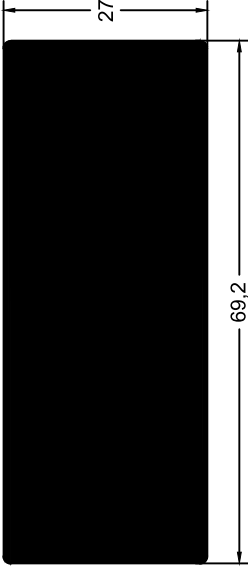
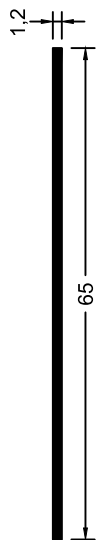
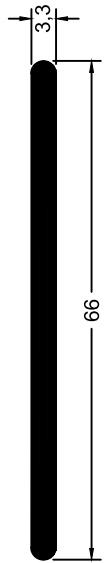

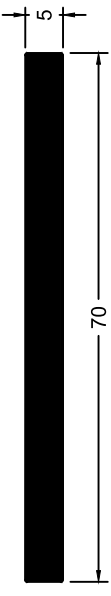
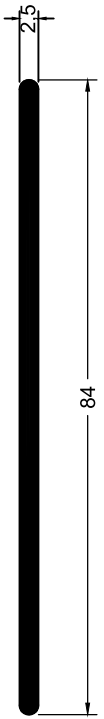
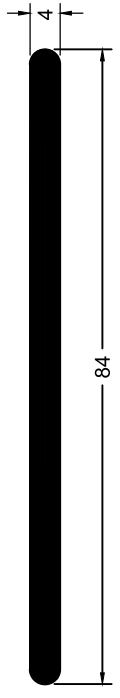
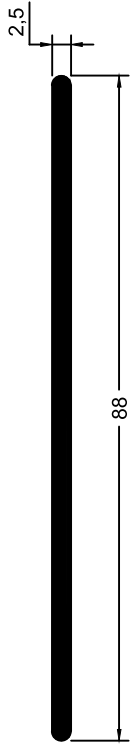
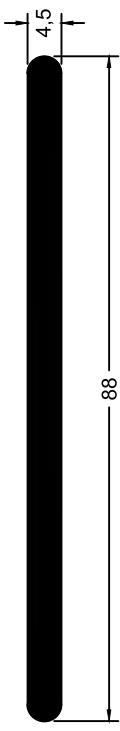
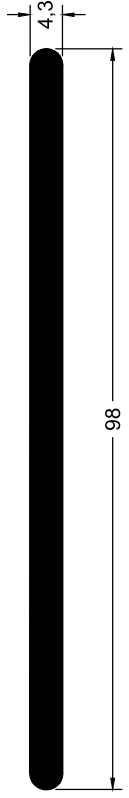
<p>CIA 6186</p> 	<p>CIA 6199</p> 	<p>CIA 6105</p> 	<p>CIA 6145</p> 
<p>CIA 6310</p> 	<p>CIA 6191 CIA 16211#</p> 	<p>CIA 6450</p> 	<p>CIA 6276***</p> 
<p>CIA 6237*** CIA 6280***</p> 	<p>CIA 6298***</p> 	<p>CIA 6257***</p> 	<p>CIA 14205**</p> 
<p>CIA 6409**</p> 	<p>CIA 17389</p> 	<p>CIA 6344**</p> 	<p>CIA 6024**</p> 

<p>CIA 6137</p>  <p>45 30</p>	<p>CIA 6115</p>  <p>50 30</p>	<p>CIA 6442** CIA 6453***</p>  <p>50 3</p>	<p>CIA 6200</p>  <p>50 6</p>
<p>CIA 6264***</p>  <p>54 3,3</p>	<p>CIA 6287***</p>  <p>54 4,5</p>	<p>CIA 6277***</p>  <p>54 2,5</p>	<p>CIA 6114</p>  <p>60 30</p>
<p>CIA 6267***</p>  <p>54 6,6</p>	<p>CIA 6299***</p>  <p>54 5</p>		

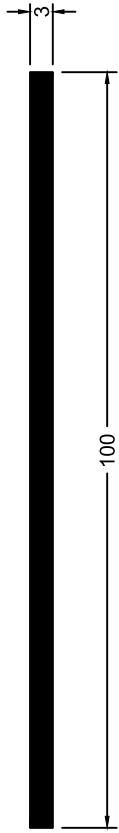
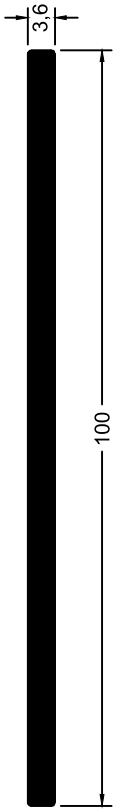
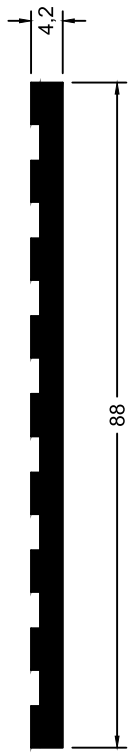
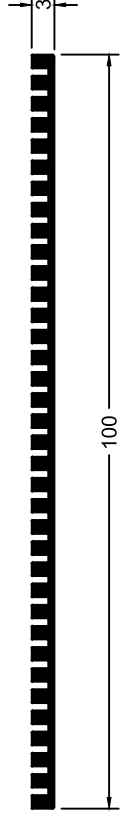
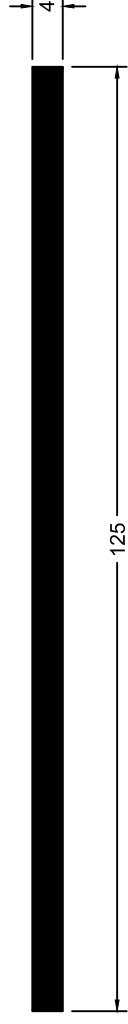
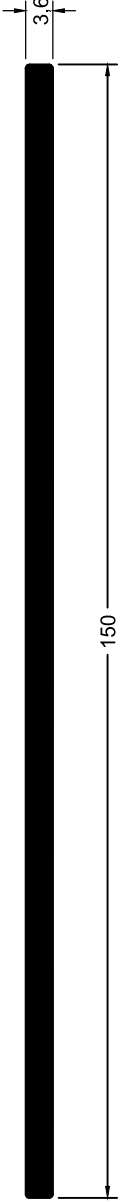
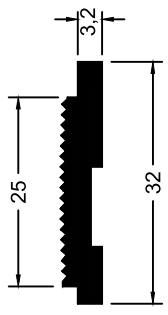
<p>CIA 6271</p> 	<p>CIA 6253***</p> 	<p>CIA 6252***</p> 
<p>CIA 6251***</p> 	<p>CIA 6209</p> 	<p>CIA 17325</p> 
<p>CIA 17340</p> 	<p>CIA 6282***</p> 	

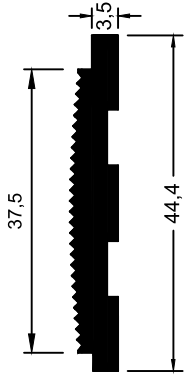
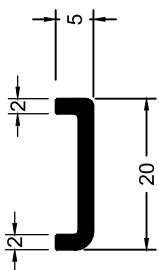
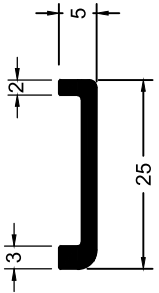
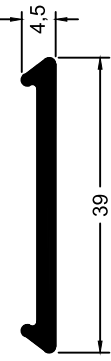
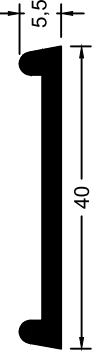
<p>C/A 6283***</p> 	<p>C/A 6144</p> 
<p>C/A 6248***</p> 	<p>C/A 6249***</p> 
<p>C/A 6278***</p> 	<p>C/A 6279***</p> 
<p>C/A 6250***</p> 	<p>C/A 6270</p> 

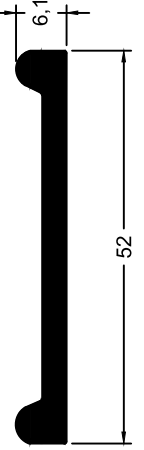
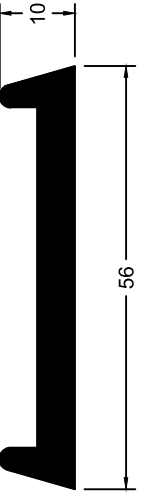
<p>CIA 9155</p> 	<p>CIA 6290</p> 
<p>CIA 6326</p> 	<p>CIA 6152** CIA 16679</p> 
<p>CIA 14619#</p> 	
<p>CIA 7077#</p> 	<p>CIA 14260**</p> 

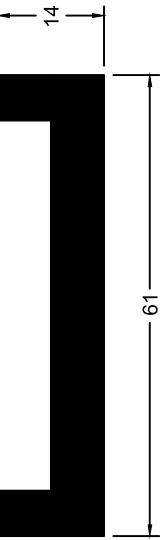
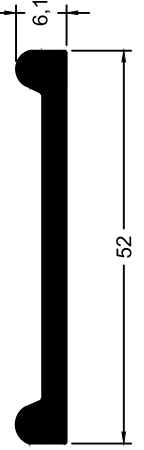
<p>CIA 15887 CIA 16587</p> 	<p>CIA 6402</p> 	<p>CIA 6401</p> 	<p>CIA 6082</p> 
<p>CIA 17171</p> 	<p>CIA 16473</p> 	<p>CIA 6413**</p> 	<p>CIA 6076</p> 
<p>CIA 14089**</p> 	<p>CIA 6142** CIA 17237</p> 		<p>CIA 6055</p> 
<p>CIA 6418</p> 		<p>CIA 6076</p> 	

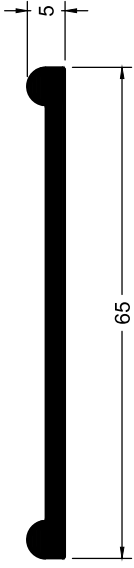
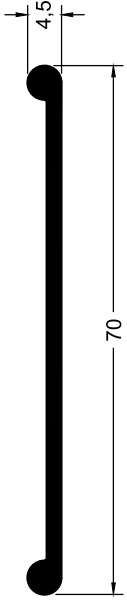
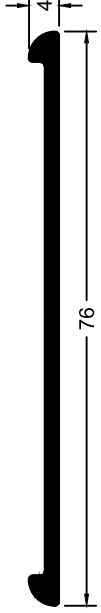
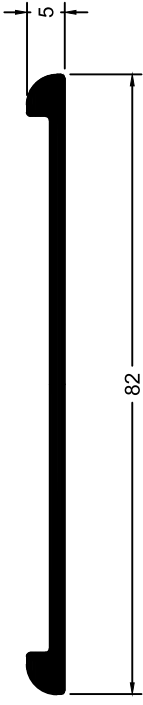
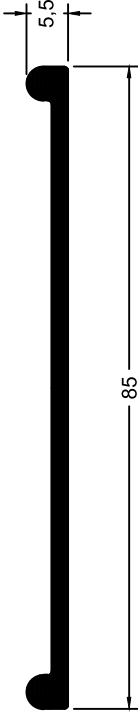
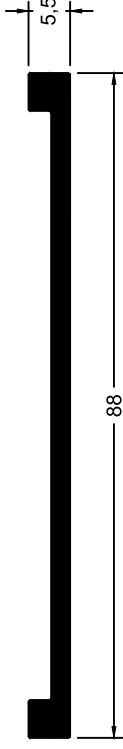
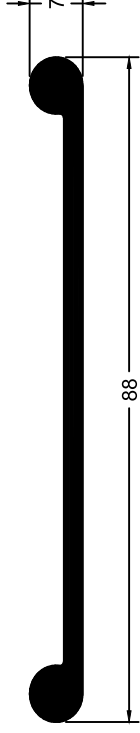
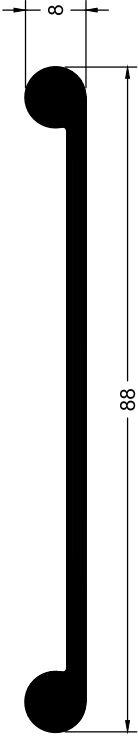
<p>CIA 6204</p> 	<p>CIA 6195**</p> 
<p>CIA 16474</p> 	<p>CIA 7052 #</p> 
<p>CIA 6352 CIA 16564</p> 	<p>CIA 6343</p> 
<p>CIA 7051 #</p> 	<p>CIA 6194</p> 

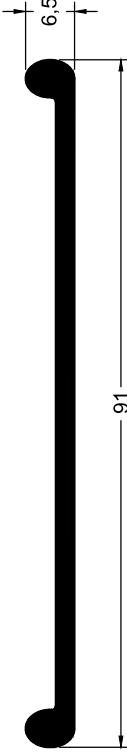
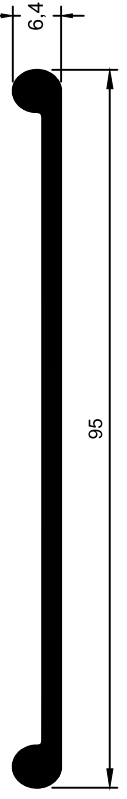
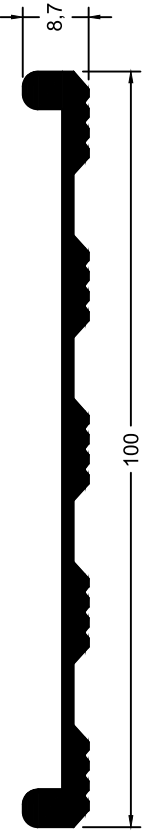
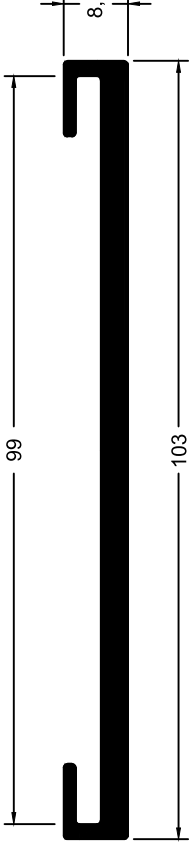
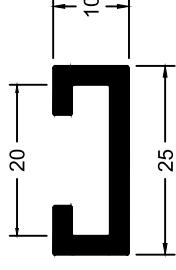
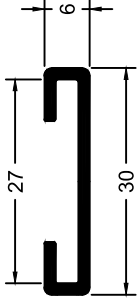
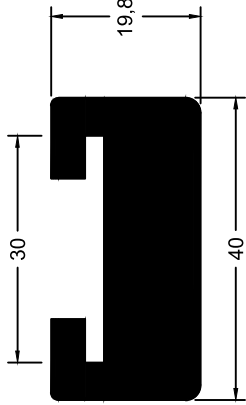
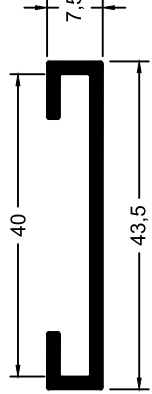
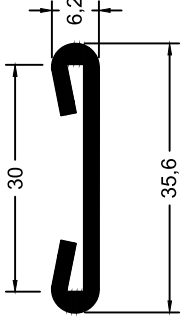
<p>CIA 6237** CIA 16801</p> 	<p>CIA 7050 #</p> 
<p>CIA 6364</p> 	<p>CIA 6302</p> 
<p>CIA 6371*</p> 	<p>CIA 6366</p> 
<p>CIA 16817*</p> 	<p>CIA 6150**</p> 
	<p>CIA 17172**</p> 

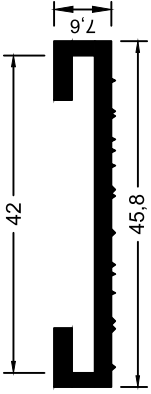
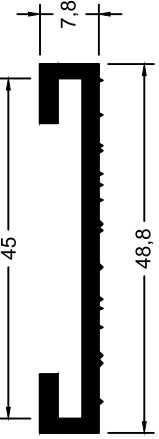
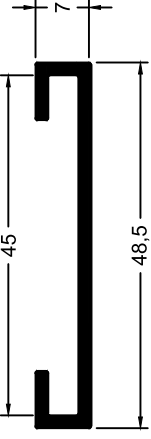
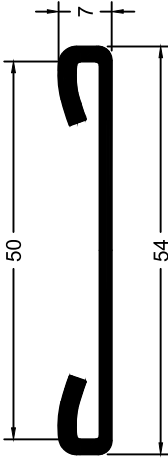
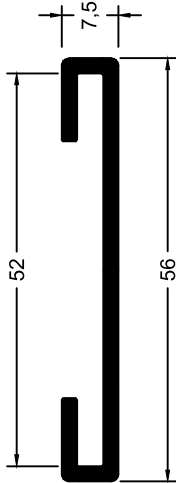
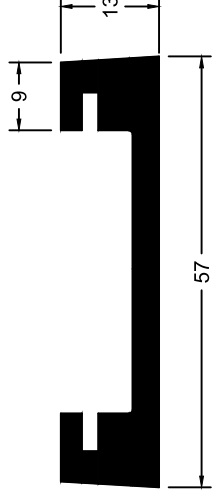
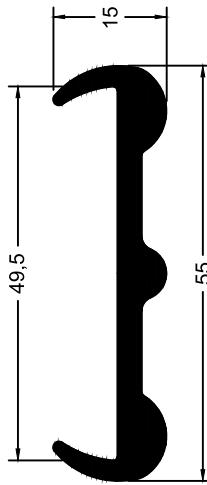
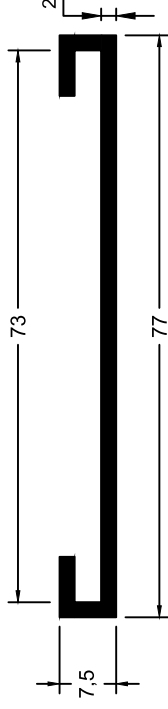
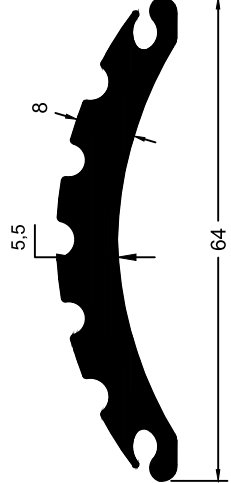
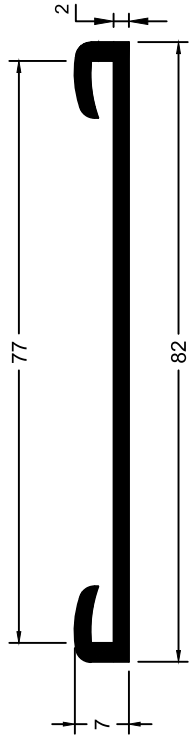

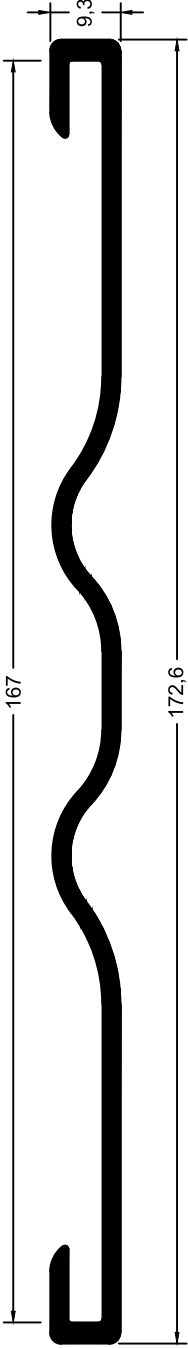
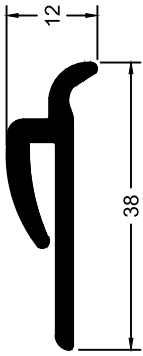
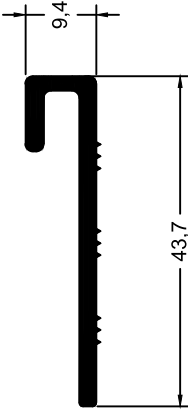
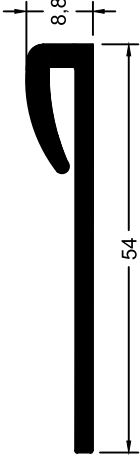
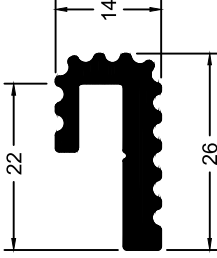
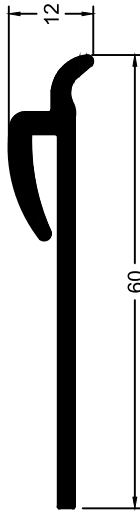
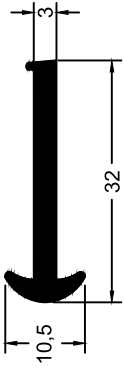
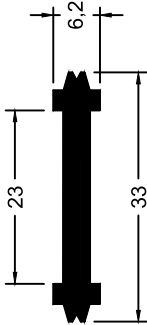
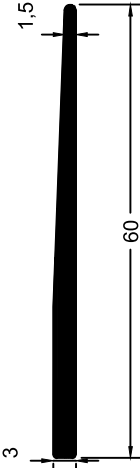
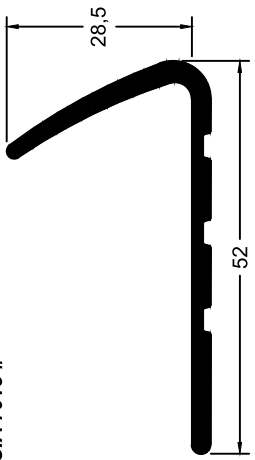
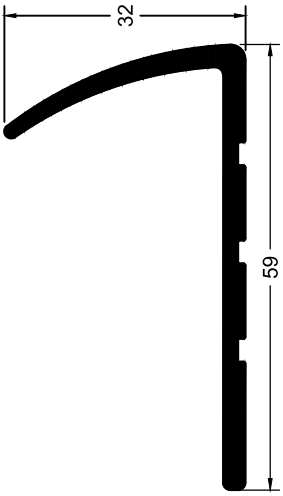
<p>CIA 16707**</p>  <p>Dimensions: 42, 45,8, 7,6</p>	<p>CIA 16708***</p>  <p>Dimensions: 45, 48,8, 7,8</p>	<p>CIA 6151</p>  <p>Dimensions: 45, 48,5, 7</p>
<p>CIA 6127</p>  <p>Dimensions: 50, 54, 7</p>	<p>CIA 6365</p>  <p>Dimensions: 52, 56, 7,5</p>	<p>CIA 6074</p>  <p>Dimensions: 9, 13, 57</p>
<p>CIA 6068</p>  <p>Dimensions: 49,5, 55, 15</p>	<p>CIA 15980**</p>  <p>Dimensions: 7,5, 73, 77, 2</p>	<p>CIA 6306**</p>  <p>Dimensions: 5,5, 8, 64</p>
<p>CIA 15623**</p>  <p>Dimensions: 7, 77, 82, 2</p>		

<p>CIA 17387</p> 			
<p>CIA 14954</p> 	<p>CIA 17332***</p> 	<p>CIA 16326**</p> 	<p>CIA 6454**</p> 
<p>CIA 6058</p> 	<p>CIA 6095</p> 	<p>CIA 6084**</p> 	
<p>CIA 6309**</p> 	<p>CIA 7018 #</p> 	<p>CIA 6206**</p> 	

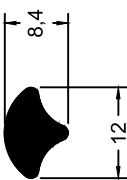
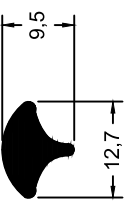
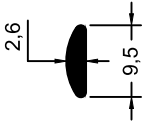
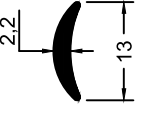
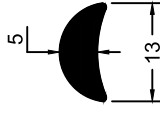
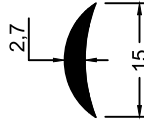
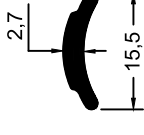
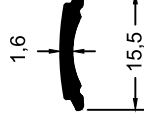
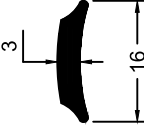
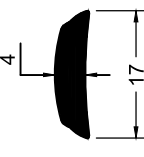
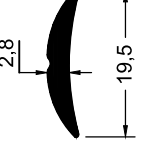
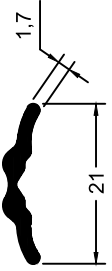
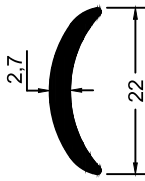
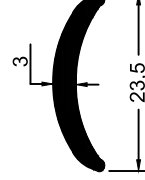
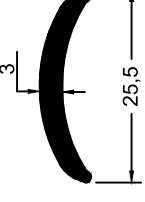
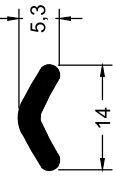

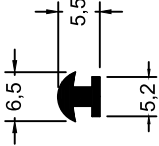
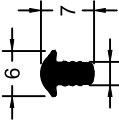
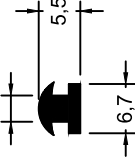
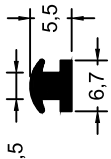
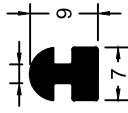
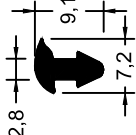
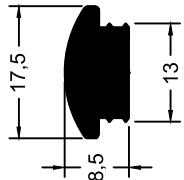
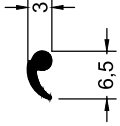
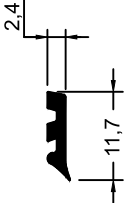
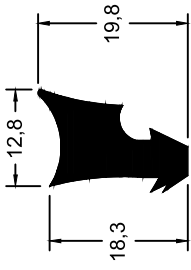
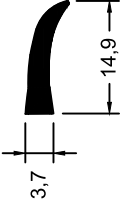
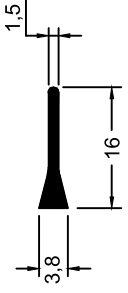
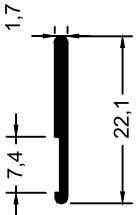
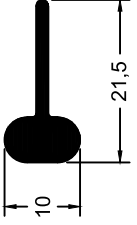
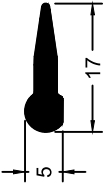
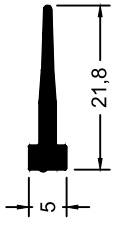
<p>CIA 16212**</p>	<p>CIA 7016 #</p>	<p>CIA 6228**</p>	<p>CIA 6124**</p>
<p>CIA 6430**(80 Shore A) CIA 16806**</p>	<p>CIA 16266**</p>	<p>CIA 14840**(80 Shore A) CIA 16300**</p>	<p>CIA 6410**</p>
<p>CIA 7058 #</p>	<p>CIA 6368**</p>	<p>CIA 6308**</p>	<p>CIA 6307**</p>
<p>CIA 6026**</p>	<p>CIA 6030</p>	<p>CIA 6029**</p>	<p>CIA 6027**</p>

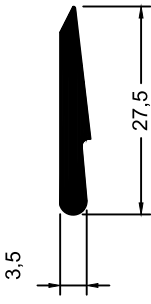
<p>CIA 6472**</p> 	<p>CIA 6028**</p> 	<p>CIA 7054 #</p> 	<p>CIA 7048 #</p> 
<p>CIA 6338</p> 	<p>CIA 6048** CIA 7075 #</p> 	<p>CIA 7002 #</p> 	<p>CIA 14833 #</p> 
<p>CIA 6265**</p> 	<p>CIA 6197**</p> 	<p>CIA 6238** CIA 7065 #</p> 	<p>CIA 7041 #</p> 
<p>CIA 7057#</p> 	<p>CIA 7023#</p> 	<p>CIA 7019#</p> 	<p>CIA 6241**</p> 

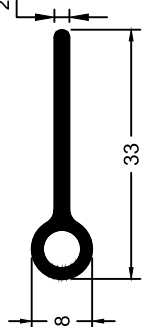
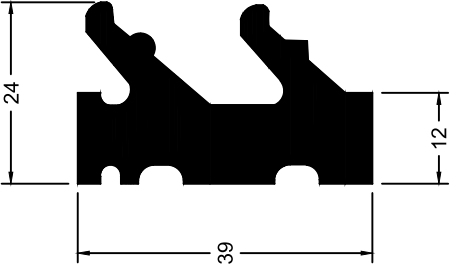
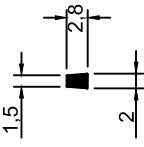
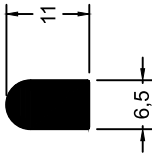
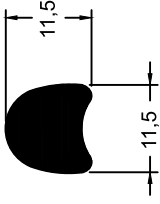
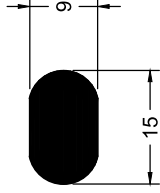
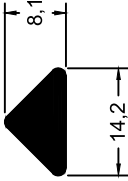
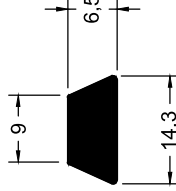
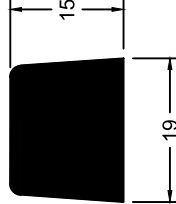
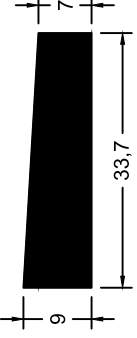
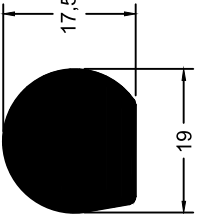
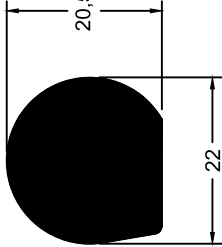
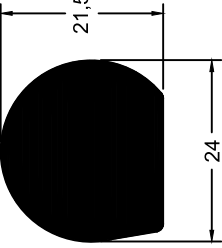
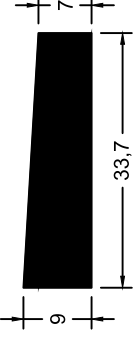

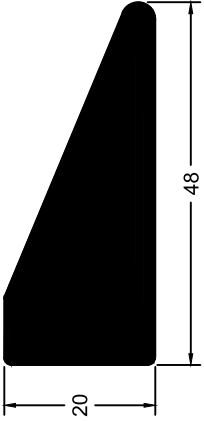
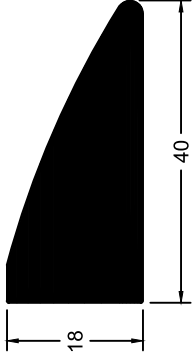
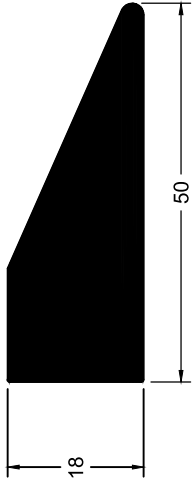
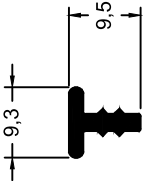
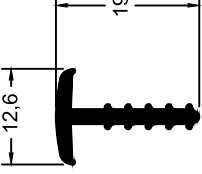
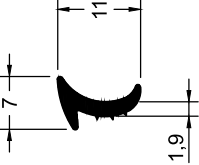
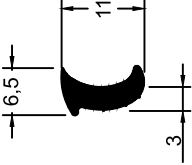
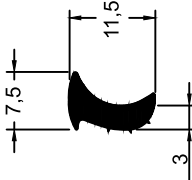
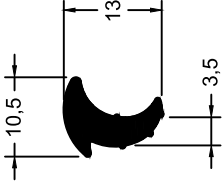
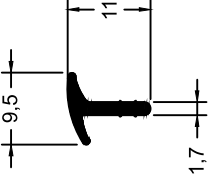
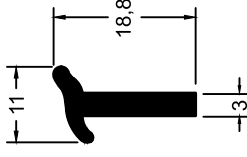
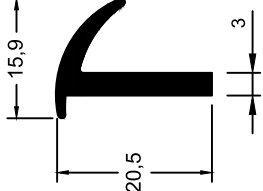
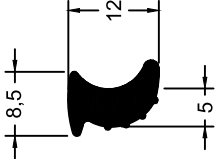
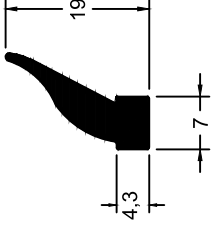
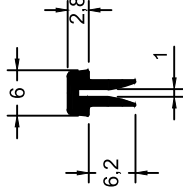
<p>CIA 7069 #</p> 	<p>CIA 15711 #</p> 	<p>CIA 14832#</p> 	<p>CIA 16721**</p> 
<p>CIA 16238**</p> 	<p>CIA 17222**</p> 	<p>CIA 15780**</p> 	<p>CIA 6242**</p> 
<p>CIA 6081</p> 	<p>CIA 15750**</p> 	<p>CIA 14250**</p> 	<p>CIA 6173</p> 
<p>CIA 16746 #</p> 	<p>CIA 7031 #</p> 	<p>CIA 16867**</p> 	<p>CIA 16618 #</p> 

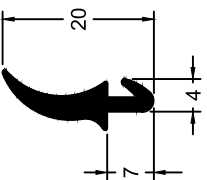
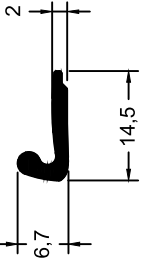
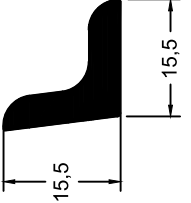
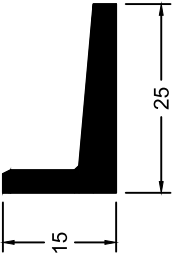
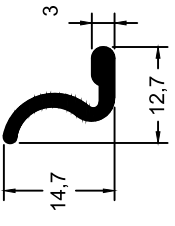
<p>CIA 7083 #</p>  <p>3,5 27,5</p>	<p>CIA 14317*</p>  <p>4,4 31,9</p>	<p>CIA 16897#</p>  <p>8 33</p>	<p>CIA 15703**</p>  <p>39 24 12</p>
<p>CIA 6052**</p>  <p>1,5 2,8 2</p>	<p>CIA 6394***</p>  <p>11 6,5</p>	<p>CIA 6130</p>  <p>11,5 11,5</p>	<p>CIA 6133</p>  <p>9 15</p>
<p>CIA 6480**</p>  <p>8,1 14,2</p>	<p>CIA 6117</p>  <p>9 14,3 6,5</p>	<p>CIA 6457**</p>  <p>15 19</p>	<p>CIA 17327**</p>  <p>9 7 33,7</p>
<p>CIA 14453</p>  <p>17,5 19</p>	<p>CIA 14365</p>  <p>20,5 22</p>	<p>CIA 14454</p>  <p>21,5 24</p>	<p>CIA 17327**</p>  <p>9 7 33,7</p>

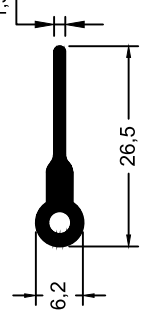
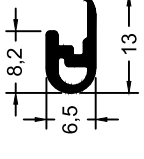
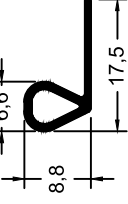
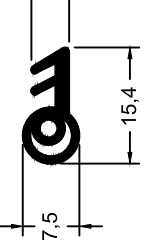
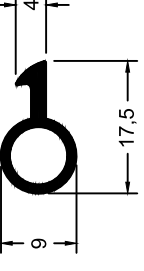
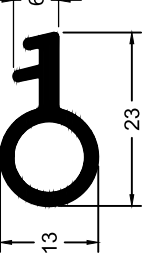
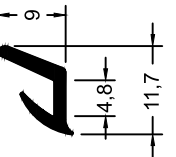
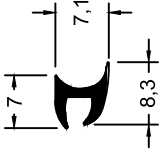
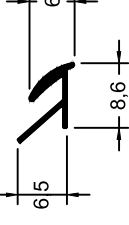
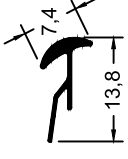
<p>CIA 6322</p> 	<p>CIA 6101 CIA 6182**</p> 	<p>CIA 6216</p> 
<p>CIA 6125**</p> 	<p>CIA 7066 #</p> 	<p>CIA 6043**</p> 
<p>CIA 6044**</p> 	<p>CIA 6073**</p> 	<p>CIA 6406**</p> 
<p>CIA 6301**</p> 	<p>CIA 6428**</p> 	<p>CIA 6440**</p> 
<p>CIA 6293**</p> 	<p>CIA 6383</p> 	<p>CIA 6412**</p> 

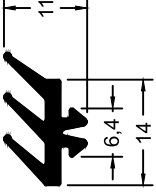
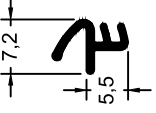
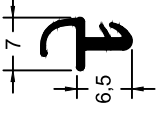
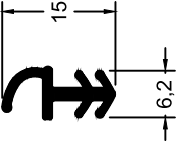
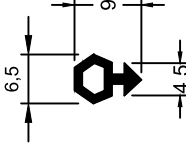
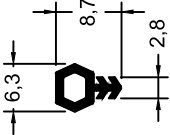
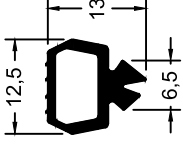
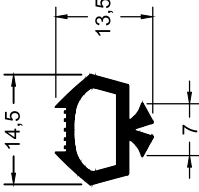
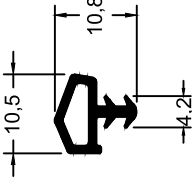
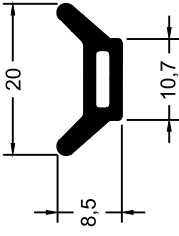
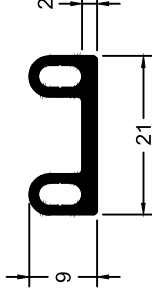
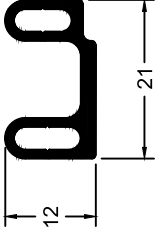
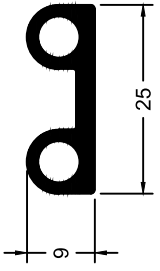
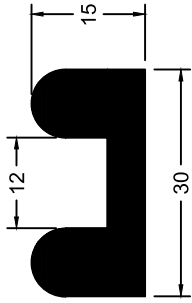
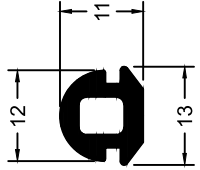
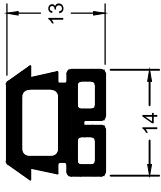
<p>CIA 6078**</p>  <p>Dimensions: 20, 7, 4</p>	<p>CIA 6313**</p>  <p>Dimensions: 6,7, 2, 14,5</p>	<p>CIA 6054</p>  <p>Dimensions: 15,5, 15,5</p>	<p>CIA 6432**</p>  <p>Dimensions: 15, 25</p>
<p>CIA 14838 #</p>  <p>Dimensions: 14,7, 3, 12,7</p>	<p>CIA 6042**</p>  <p>Dimensions: 10, 4,6, 17</p>	<p>CIA 6439**</p>  <p>Dimensions: 6,2, 1,5, 26,5</p>	<p>CIA 16574**</p>  <p>Dimensions: 8,2, 6,5, 13</p>
<p>CIA 17012**</p>  <p>Dimensions: 8,8, 6,6, 17,5</p>	<p>CIA 6181**</p>  <p>Dimensions: 7,5, 5, 15,4</p>	<p>CIA 6089**</p>  <p>Dimensions: 9, 4, 17,5</p>	<p>CIA 6207**</p>  <p>Dimensions: 13, 6, 23</p>
<p>CIA 6485**</p>  <p>Dimensions: 9, 4,8, 11,7</p>	<p>CIA 6469**</p>  <p>Dimensions: 7, 7,1, 8,3</p>	<p>CIA 6470**</p>  <p>Dimensions: 6,5, 6, 8,6</p>	<p>CIA 6482**</p>  <p>Dimensions: 7,4, 13,8</p>

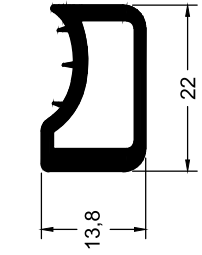
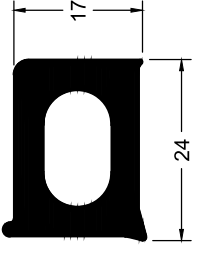
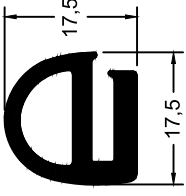
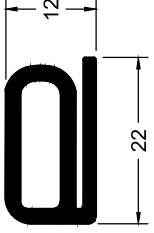
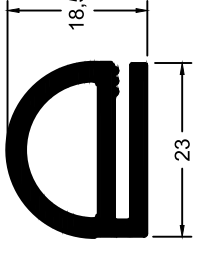
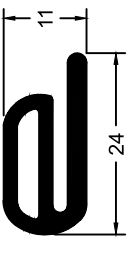
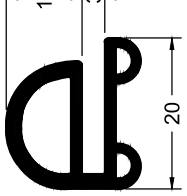
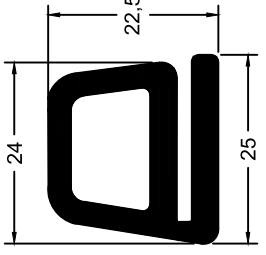
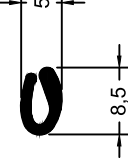
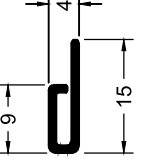
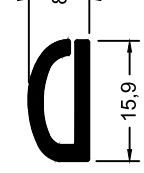
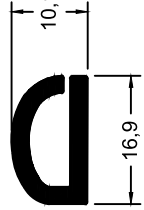
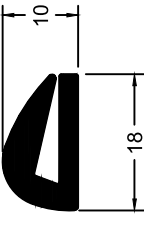
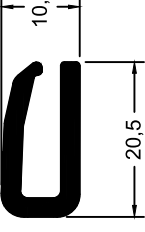
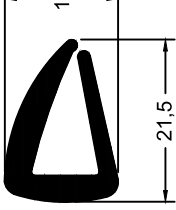
<p>CIA 6289**</p> 	<p>CIA 7028 #</p> 	<p>CIA 6189** CIA 7033 #</p> 	<p>CIA 6305**</p> 
<p>CIA 6158**</p> 	<p>CIA 7020 #</p> 	<p>CIA 6246**</p> 	<p>CIA 6153**</p> 
<p>CIA 7059 #</p> 	<p>CIA 6303**</p> 	<p>CIA 6315**</p> 	<p>CIA 6355**</p> 
<p>CIA 6385</p> 	<p>CIA 17072**</p> 	<p>CIA 6172**</p> 	<p>CIA 6225*</p> 

<p>CIA 6129</p> 	<p>CIA 6132</p> 	<p>CIA 6400**</p> 	<p>CIA 6179**</p> 
<p>CIA 6333</p> 	<p>CIA 7038 #</p> 	<p>CIA 6180**</p> 	<p>CIA 6161**</p> 
<p>CIA 6349**</p> 	<p>CIA 6235** CIA 6236**</p> 	<p>CIA 6111** (Cinza)</p> 	<p>CIA 6112**</p> 
<p>CIA 6353**</p> 	<p>CIA 7014 #</p> 	<p>CIA 6288**</p> 	<p>CIA 15819 #</p> 

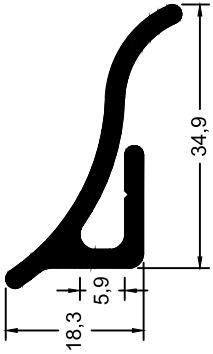
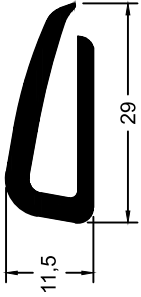
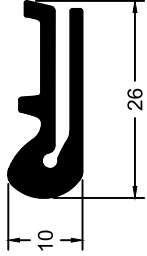
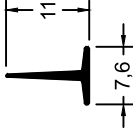
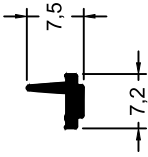
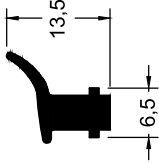
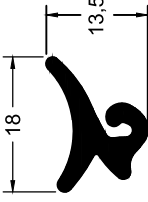
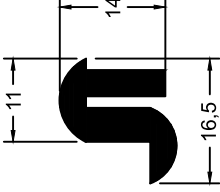
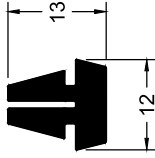
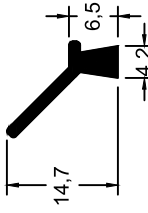
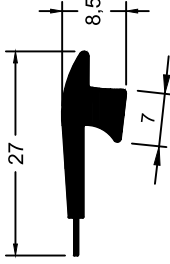
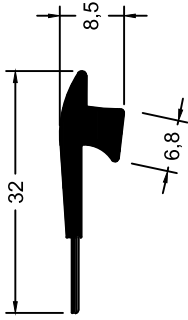
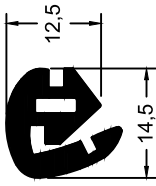
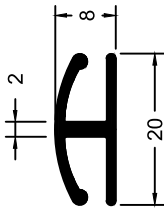
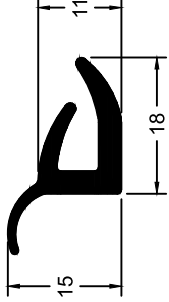
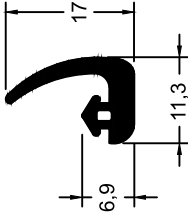
<p>CIA 16536**</p> 	<p>CIA 14836 #</p> 	<p>CIA 6370*</p> 	<p>CIA 6319**</p> 
<p>CIA 6171**</p> 	<p>CIA 6157**</p> 	<p>CIA 6217</p> 	<p>CIA 6465**</p> 
<p>CIA 6198**</p> 	<p>CIA 6243**</p> 	<p>CIA 6373**</p> 	<p>CIA 6459**</p> 
<p>CIA 6337**</p> 	<p>CIA 7060 #</p> 	<p>CIA 7070 #</p> 	<p>CIA 6399**</p> 

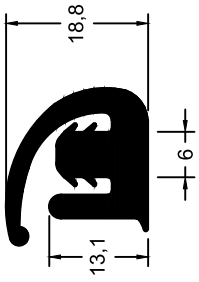
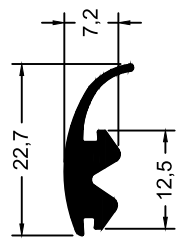
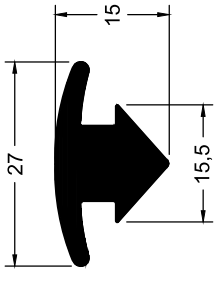
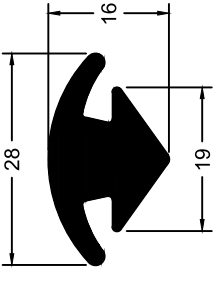
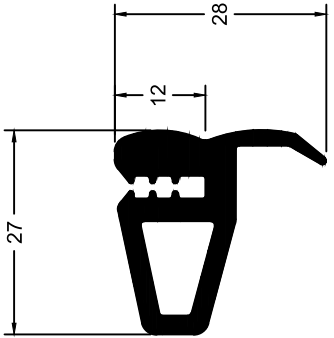
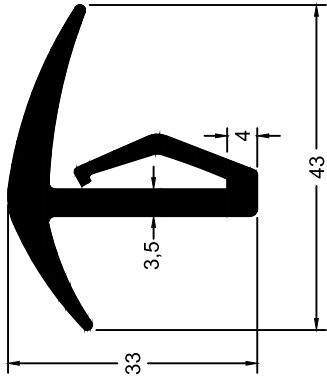
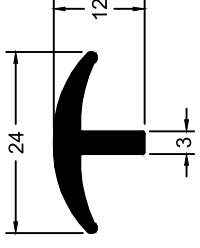
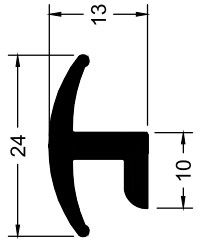
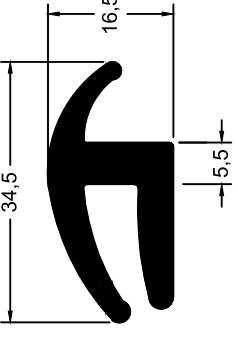
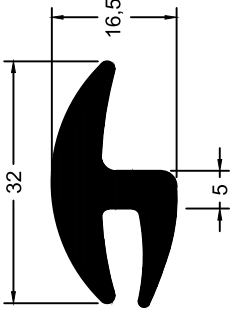
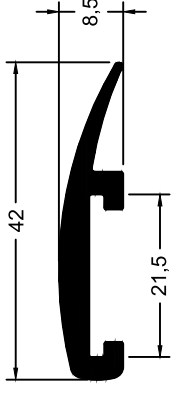
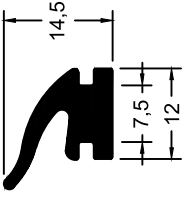
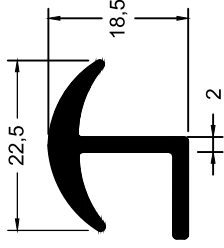
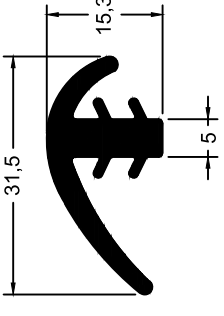
<p>CIA 16436**</p> 	<p>CIA 7061 #</p> 	<p>CIA 6230**</p> 	<p>CIA 7025 #</p> 
<p>CIA 6455</p> 	<p>CIA 16083</p> 	<p>CIA 6214**</p> 	<p>CIA 6215**</p> 
<p>CIA 6110**</p> 	<p>CIA 6427**</p> 	<p>CIA 6360**</p> 	<p>CIA 6424**</p> 
<p>CIA 6069**</p> 	<p>CIA 6342**</p> 		

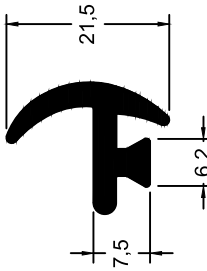
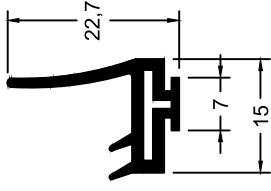
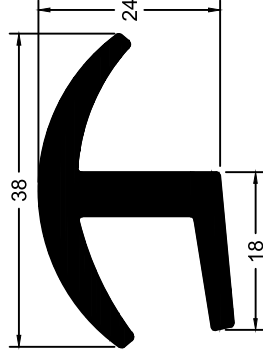
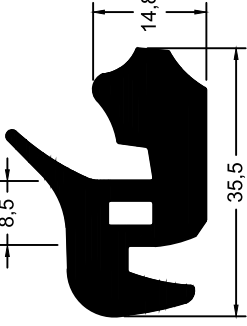
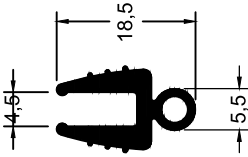
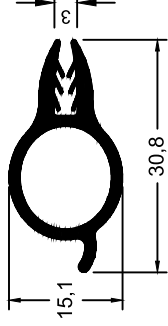
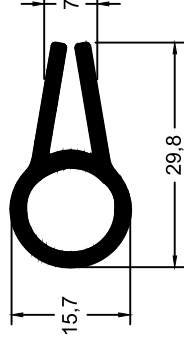
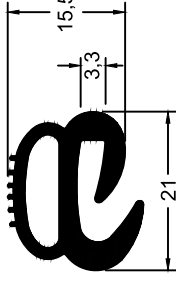
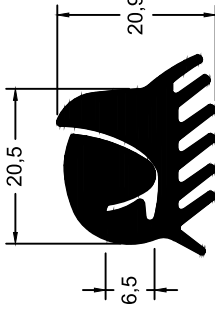
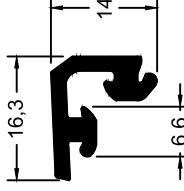
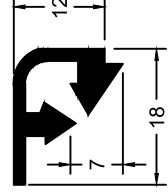
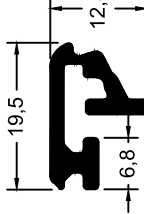
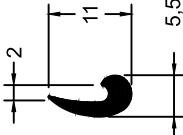
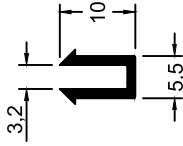
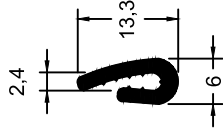
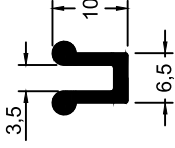
<p>CIA 6106**</p>  <p>Dimensions: 7,5, 21,5, 6,2</p>	<p>CIA 6128**</p>  <p>Dimensions: 22,7, 7, 15</p>	<p>CIA 6408**</p>  <p>Dimensions: 38, 24, 18</p>	<p>CIA 6378**</p>  <p>Dimensions: 8,5, 14,8, 35,5</p>
<p>CIA 6226**</p>  <p>Dimensions: 4,5, 18,5, 5,5</p>	<p>CIA 17314**</p>  <p>Dimensions: 15,1, 30,8</p>	<p>CIA 6436</p>  <p>Dimensions: 15,7, 7, 29,8</p>	<p>CIA 6354**</p>  <p>Dimensions: 15,5, 3,3, 21</p>
<p>CIA 6093**</p>  <p>Dimensions: 6,5, 20,5, 20,9</p>	<p>CIA 15251 #</p>  <p>Dimensions: 16,3, 14, 6,6</p>	<p>CIA 14117 #</p>  <p>Dimensions: 7, 12, 18</p>	<p>CIA 14413 #</p>  <p>Dimensions: 19,5, 6,8, 12,8</p>
<p>CIA 14526</p>  <p>Dimensions: 2, 11, 5,5</p>	<p>CIA 6121**</p>  <p>Dimensions: 3,2, 10, 5,5</p>	<p>CIA 6509**</p>  <p>Dimensions: 2,4, 13,3, 6</p>	<p>CIA 6041</p>  <p>Dimensions: 3,5, 10, 6,5</p>

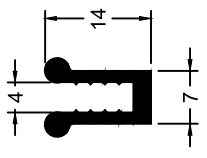
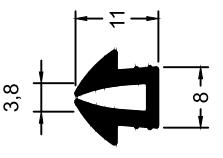
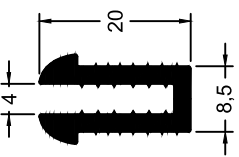
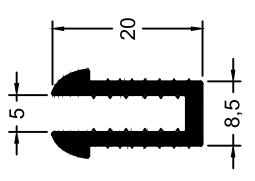
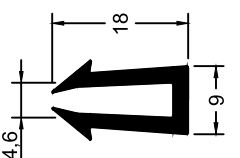
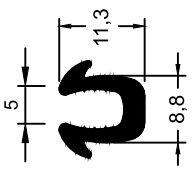
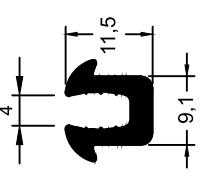
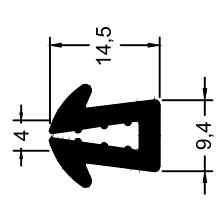
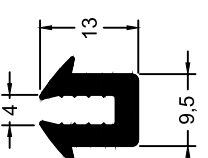
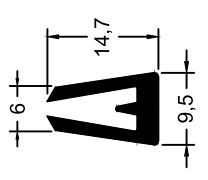
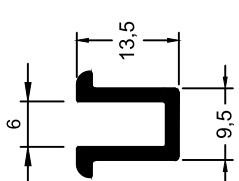
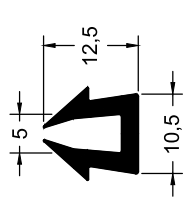
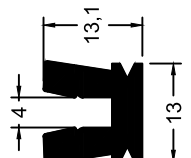
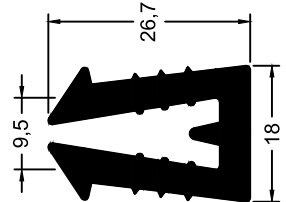
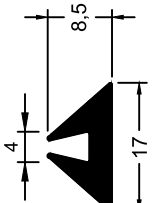
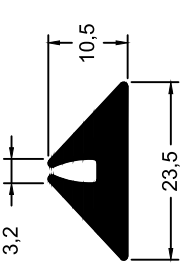
<p>CIA 16805**</p>  <p>Dimensions: 4, 14, 7</p>	<p>CIA 6372**</p>  <p>Dimensions: 3,8, 11, 8</p>	<p>CIA 6126</p>  <p>Dimensions: 4, 20, 8,5</p>	<p>CIA 6116</p>  <p>Dimensions: 5, 20, 8,5</p>
<p>CIA 6118**</p>  <p>Dimensions: 4,6, 18, 9</p>	<p>CIA 6034**</p>  <p>Dimensions: 5, 11,3, 8,8</p>	<p>CIA 14120**</p>  <p>Dimensions: 4, 11,5, 9,1</p>	<p>CIA 6396**</p>  <p>Dimensions: 4, 14,5, 9,4</p>
<p>CIA 14029**</p>  <p>Dimensions: 4, 13, 9,5</p>	<p>CIA 6381**</p>  <p>Dimensions: 6, 14,7, 9,5</p>	<p>CIA 6403**</p>  <p>Dimensions: 6, 13,5, 9,5</p>	<p>CIA 6120**</p>  <p>Dimensions: 5, 12,5, 10,5</p>
<p>CIA 16574**</p>  <p>Dimensions: 4, 13,1, 13</p>	<p>CIA 6390**</p>  <p>Dimensions: 9,5, 26,7, 18</p>	<p>CIA 17217***</p>  <p>Dimensions: 4, 8,5, 17</p>	<p>CIA 16778***</p>  <p>Dimensions: 3,2, 10,5, 23,5</p>

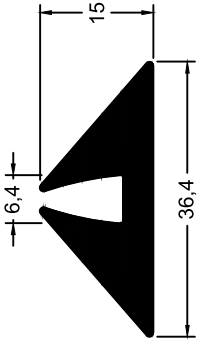
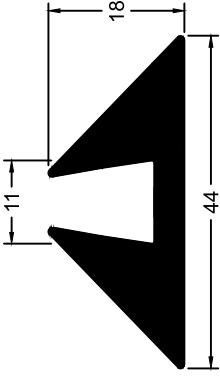
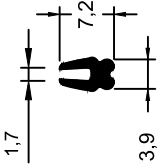
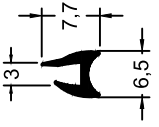
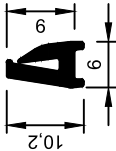
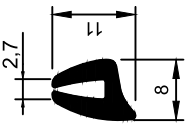
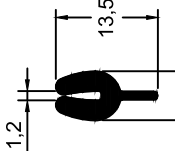
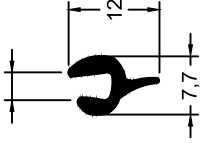
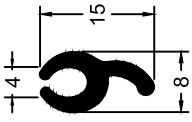
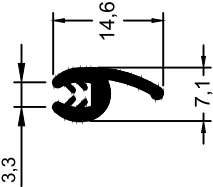
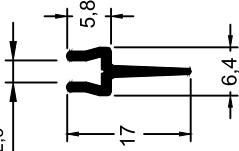
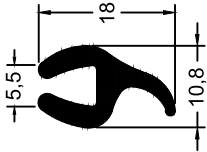
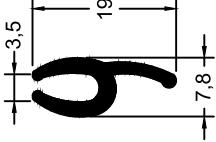
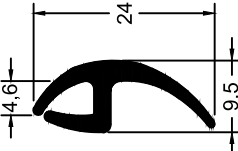
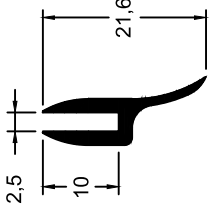
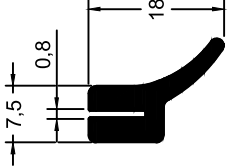
<p>CIA 16779***</p> 	<p>CIA 16892***</p> 	<p>CIA 6169**</p> 	<p>CIA 6434**</p> 
<p>CIA 6075</p> 	<p>CIA 6348**</p> 	<p>CIA 6266</p> 	<p>CIA 14114**</p> 
<p>CIA 6391**</p> 	<p>CIA 17173 #</p> 	<p>CIA 6170**</p> 	<p>CIA 6178**</p> 
<p>CIA 6335** CIA 7009 #</p> 	<p>CIA 7004 #</p> 	<p>CIA 14450**</p> 	<p>CIA 6143</p> 

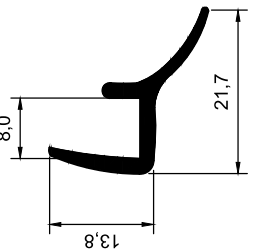
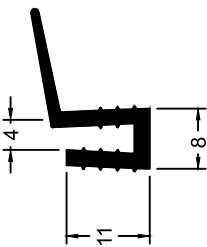
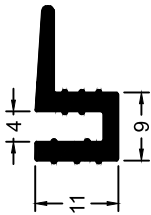
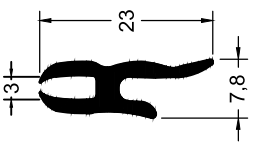
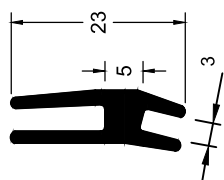
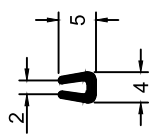
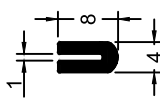
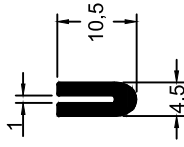
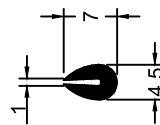
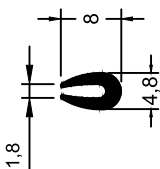
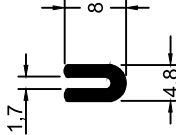
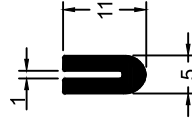
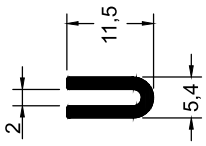
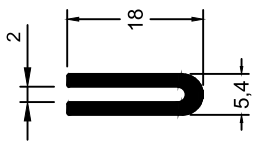
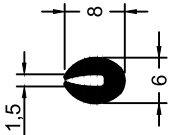
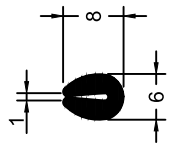
<p>CIA 6490**</p>  <p>Dimensions: 8,0 (top flange height), 13,8 (web height), 21,7 (total height), 3 (web thickness).</p>	<p>CIA 6462**</p>  <p>Dimensions: 4 (flange height), 11 (web height), 8 (total height), 4 (web thickness).</p>	<p>CIA 6291**</p>  <p>Dimensions: 4 (flange height), 11 (web height), 9 (total height), 4 (web thickness).</p>	<p>CIA 6220**</p>  <p>Dimensions: 3 (flange height), 23 (web height), 7,8 (total height), 3 (web thickness).</p>
<p>CIA 14088**</p>  <p>Dimensions: 23 (web height), 5 (flange height), 3 (web thickness).</p>	<p>CIA 6167**</p>  <p>Dimensions: 2 (flange height), 5 (web height), 4 (total height), 4 (web thickness).</p>	<p>CIA 6038** CIA 15236 #</p>  <p>Dimensions: 1 (flange height), 8 (web height), 4 (total height), 4 (web thickness).</p>	<p>CIA 6057**</p>  <p>Dimensions: 1 (flange height), 10,5 (web height), 4,5 (total height), 4 (web thickness).</p>
<p>CIA 6032 CIA 15234 #</p>  <p>Dimensions: 1 (flange height), 7 (web height), 4,5 (total height), 4 (web thickness).</p>	<p>CIA 7030 #</p>  <p>Dimensions: 1,8 (flange height), 8 (web height), 4,8 (total height), 4 (web thickness).</p>	<p>CIA 6037 CIA 15235 #</p>  <p>Dimensions: 1,7 (flange height), 8 (web height), 4,8 (total height), 4 (web thickness).</p>	<p>CIA 6096** CIA 15237 #</p>  <p>Dimensions: 1 (flange height), 11 (web height), 5 (total height), 4 (web thickness).</p>
<p>CIA 6036** CIA 7079 #</p>  <p>Dimensions: 2 (flange height), 11,5 (web height), 5,4 (total height), 4 (web thickness).</p>	<p>CIA 6444**</p>  <p>Dimensions: 2 (flange height), 18 (web height), 15,4 (total height), 4 (web thickness).</p>	<p>CIA 6061**</p>  <p>Dimensions: 1,5 (flange height), 8 (web height), 6 (total height), 4 (web thickness).</p>	<p>CIA 6045 CIA 7080 #</p>  <p>Dimensions: 1 (flange height), 8 (web height), 6 (total height), 4 (web thickness).</p>

<p>CIA 6258**</p>	<p>CIA 6063**</p>	<p>CIA 14578 #</p>	<p>CIA 6035** CIA 7078 #</p>
<p>CIA 7008 #</p>	<p>CIA 6460**</p>	<p>CIA 14835 #</p>	<p>CIA 6382</p>
<p>CIA 6033**</p>	<p>CIA 6104**</p>	<p>CIA 6318**</p>	<p>CIA 6160**</p>
<p>CIA 6443**</p>	<p>CIA 6332</p>	<p>CIA 6329**</p>	<p>CIA 6327** CIA 14518**</p>

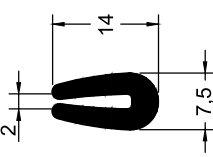
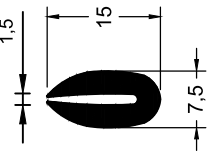
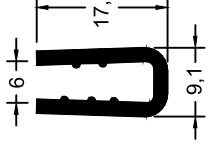
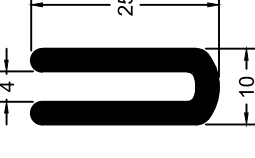
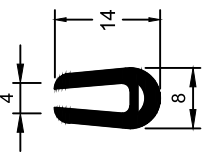
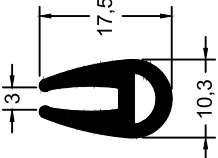
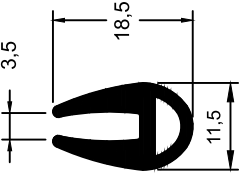
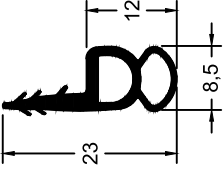
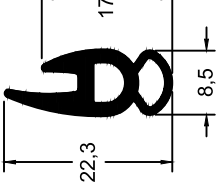
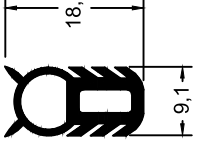
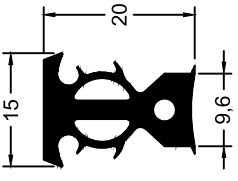
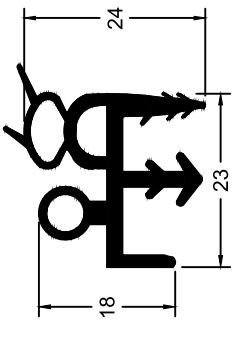
<p>CIA 6190**</p>  <p>Dimensions: 2, 14, 7,5</p>	<p>CIA 6060** CIA 15634 # CIA 6183**</p>  <p>Dimensions: 1,5, 15, 7,5</p>	<p>CIA 7010 #</p> <p>CIA 16666 #</p> <p>CIA 16176</p>  <p>Dimensions: 6, 17,3, 9,1</p>	<p>CIA 6254**</p>  <p>Dimensions: 4, 25, 10</p>	<p>CIA 7056 #</p> <p>CIA 14837 # CIA 15818 #</p> <p>CIA 7076 #</p>  <p>Dimensions: 4, 14, 8</p>	<p>CIA 6323**</p>  <p>Dimensions: 3, 17,5, 10,3</p>	<p>CIA 6445***</p>  <p>Dimensions: 3,5, 18,5, 11,5</p>	<p>CIA 7082 #</p>  <p>Dimensions: 23, 12, 8,5</p>
<p>CIA 7081 #</p>  <p>Dimensions: 22,3, 17,5, 8,5</p>	<p>CIA 14625**</p>  <p>Dimensions: 18,3, 9,1</p>	<p>CIA 16311**</p>  <p>Dimensions: 15, 20, 9,6</p>	<p>CIA 14937 #</p>  <p>Dimensions: 18, 24, 23</p>				

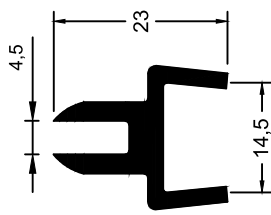
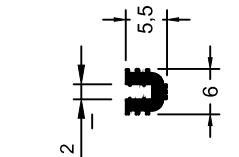
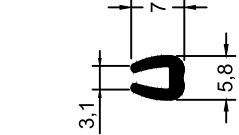
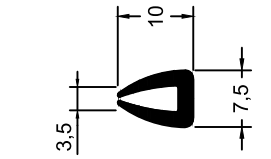
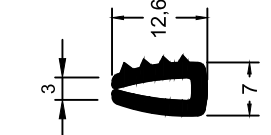
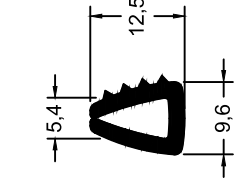
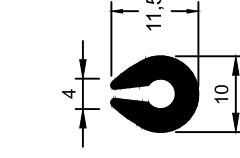
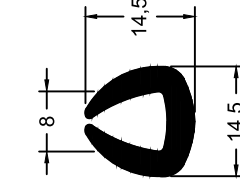
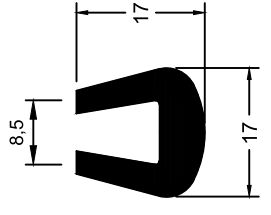
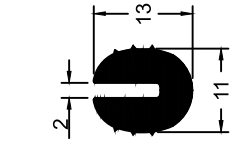
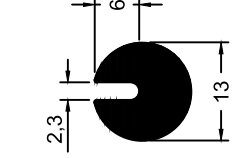
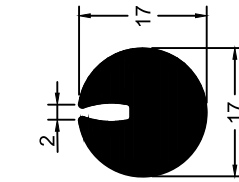
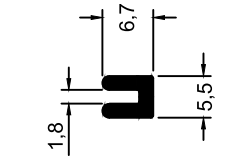
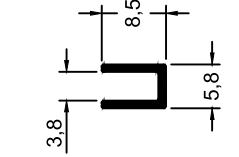
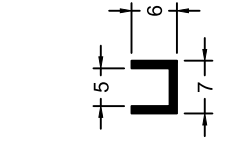
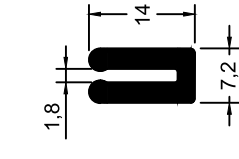
<p>CIA 15048 #</p> 	<p>CIA 6392**</p> 	<p>CIA 7049 #</p> 	<p>CIA 6087</p> 
<p>CIA 6476**</p> 	<p>CIA 6448**</p> 	<p>CIA 14170**</p> 	<p>CIA 6102**</p> 
<p>CIA 6420***</p> 	<p>CIA 6174</p> 	<p>CIA 6072***</p> 	<p>CIA 6223***</p> 
<p>CIA 6155**</p> 	<p>CIA 6067**</p> 	<p>CIA 16818**</p> 	<p>CIA 6268</p> 

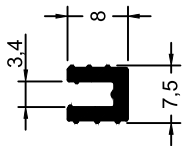
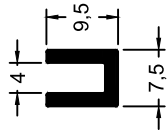
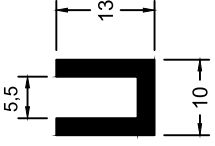
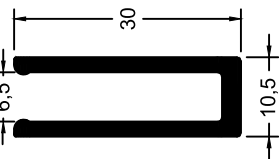
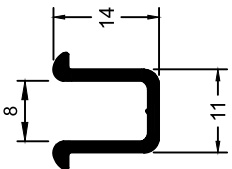
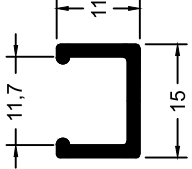
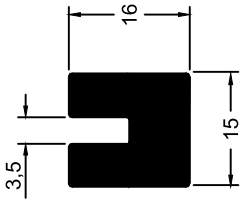
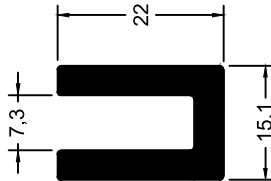
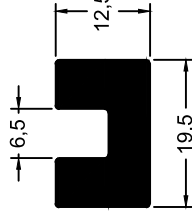
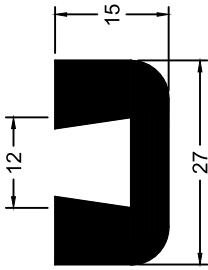
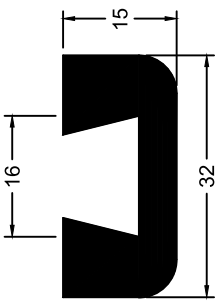
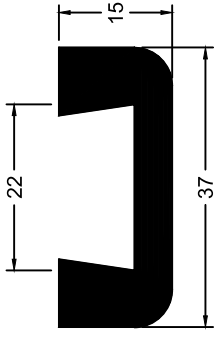
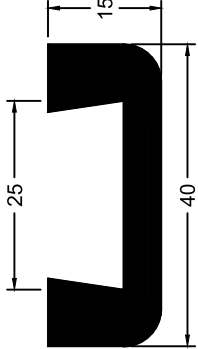
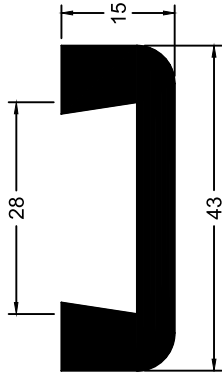
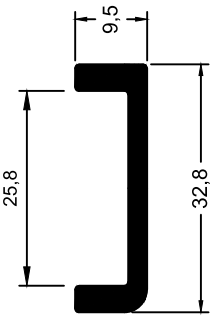
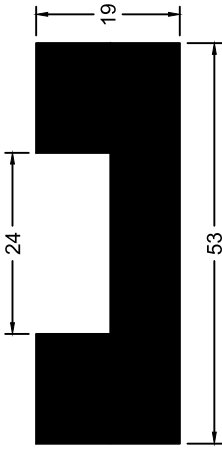
<p>CIA 6039</p> 	<p>CIA 6137**</p> 	<p>CIA 6452**</p> 	<p>CIA 6273**</p> 
<p>CIA 15781**</p> 	<p>CIA 6267**</p> 	<p>CIA 6066</p> 	<p>CIA 6040**</p> 
<p>CIA 6393***</p> 	<p>CIA 16313 (NR)</p> 	<p>CIA 16316 (NR)</p> 	<p>CIA 16315 (NR)</p> 
<p>CIA 16314 (NR)</p> 	<p>CIA 16327 (NR)</p> 	<p>CIA 6389**</p> 	<p>CIA 17049**</p> 

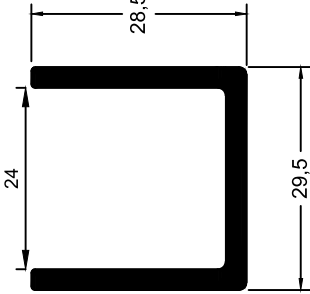
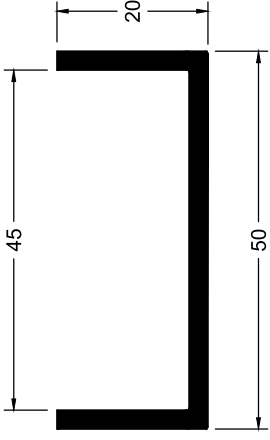
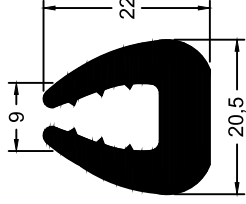
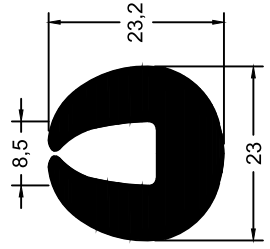
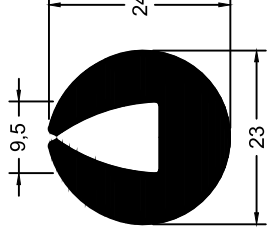
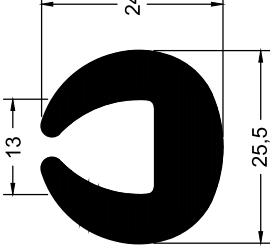
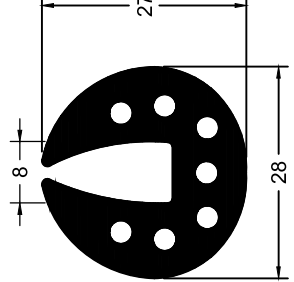
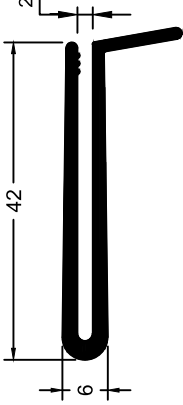
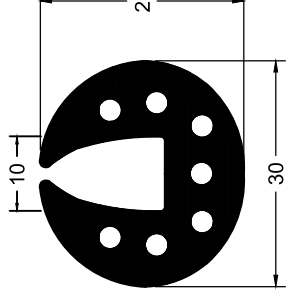
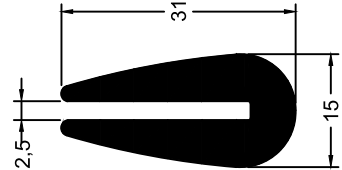
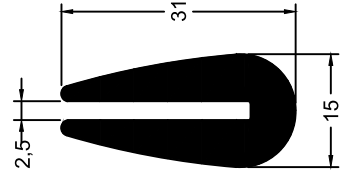
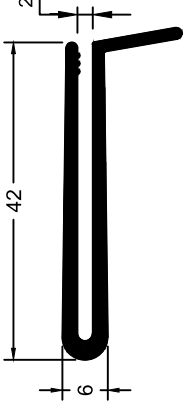
<p>CIA 7006 #</p> 	<p>CIA 6166</p> 	<p>CIA 6080**</p> 	<p>CIA 6286</p> 
<p>CIA 6300</p> 	<p>CIA 6224</p> 	<p>CIA 6244</p> 	<p>CIA 6357**</p> 
<p>CIA 6245**</p> 	<p>CIA 6149** CIA 16659 #</p> 	<p>CIA 6149** CIA 16659 #</p> 	<p>CIA 6357**</p> 

CIA 6233**

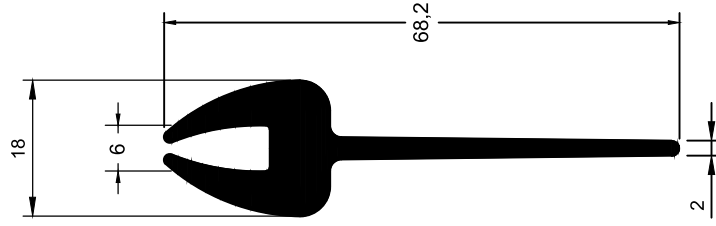

CIA 16453

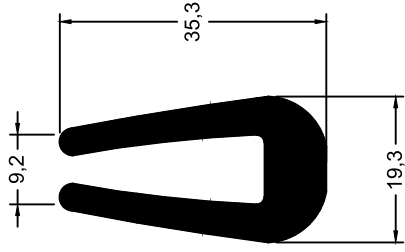

CIA 16298**

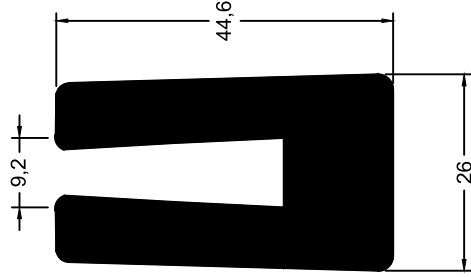

CIA 6419

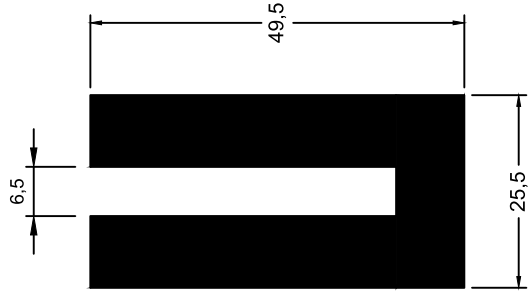

CIA 16483**

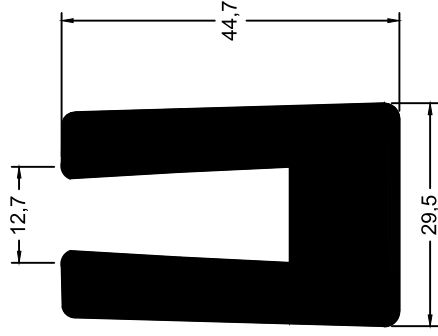

CIA 6255

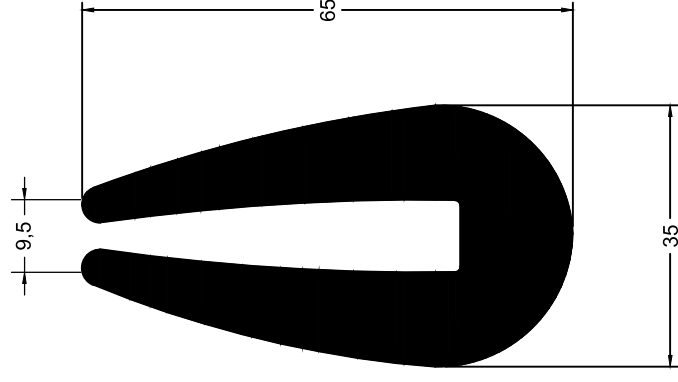

CIA 6441***

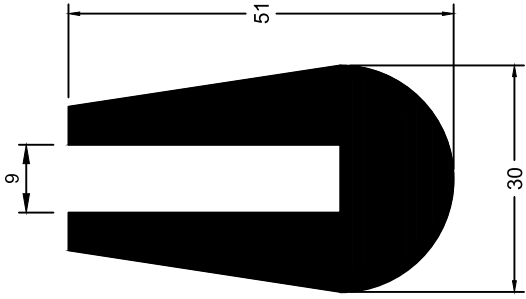

CIA 6294**

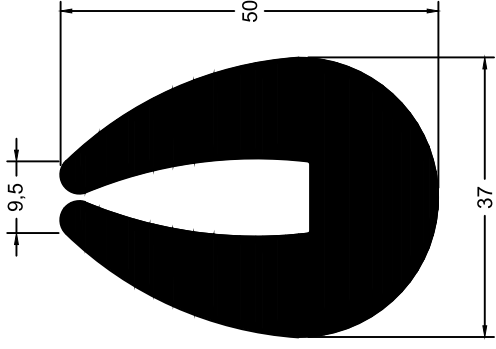

CIA 9058**

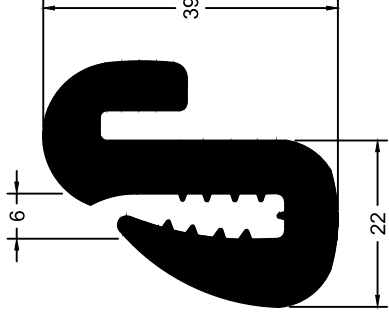

CIA 6435**

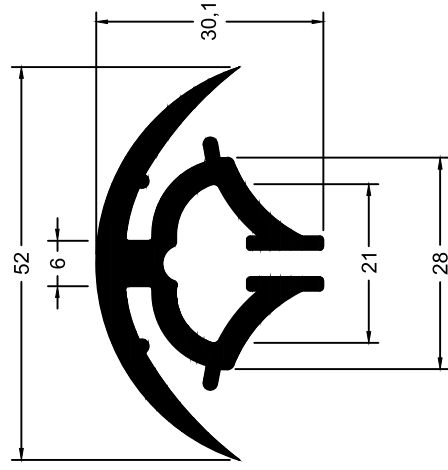

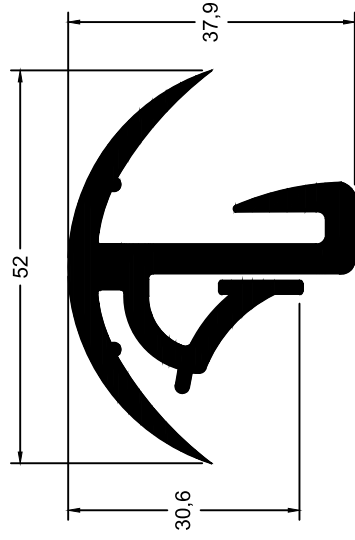

CIA 6498**

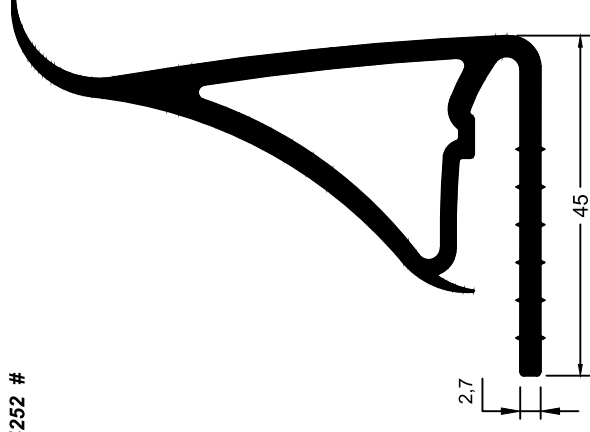

CIA 14252 #

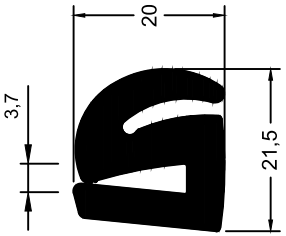
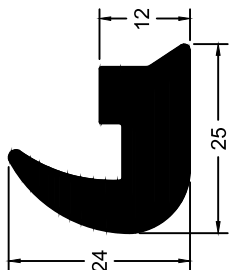
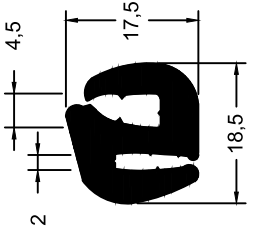
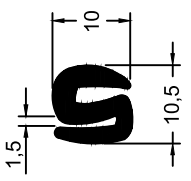
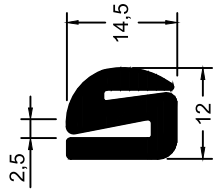
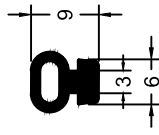
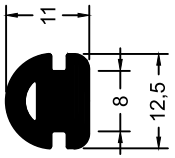
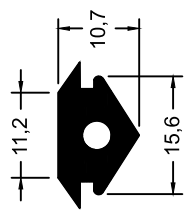
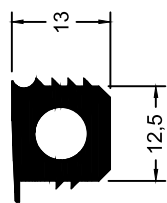
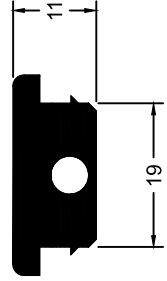
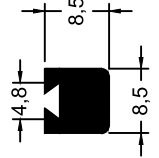
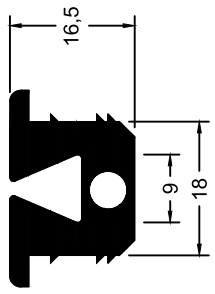

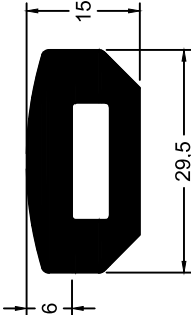
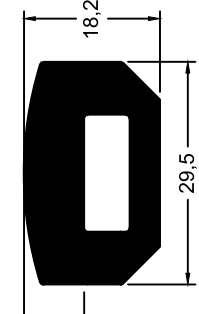
<p>CIA 9093**</p>  <p>Dimensions: 3,7, 20, 21,5</p>	<p>CIA 6456**</p>  <p>Dimensions: 24, 12, 25</p>	<p>CIA 15057**</p>  <p>Dimensions: 2, 4,5, 17,5, 18,5</p>	<p>CIA 9017** CIA 16958</p>  <p>Dimensions: 1,5, 10, 10,5</p>
<p>CIA 9023**</p>  <p>Dimensions: 2,5, 14,5, 12</p>	<p>CIA 6416**</p>  <p>Dimensions: 9, 3, 6</p>	<p>CIA 6423**</p>  <p>Dimensions: 11, 8, 12,5</p>	<p>CIA 14070**</p>  <p>Dimensions: 11,2, 10,7, 15,6</p>
<p>CIA 14379**</p>  <p>Dimensions: 13, 12,5</p>	<p>CIA 14380**</p>  <p>Dimensions: 11, 19</p>	<p>CIA 17145**</p>  <p>Dimensions: 4,8, 8,5, 8,5</p>	<p>CIA 14381**</p>  <p>Dimensions: 16,5, 9, 18</p>

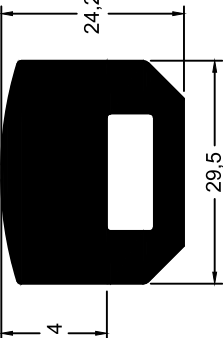
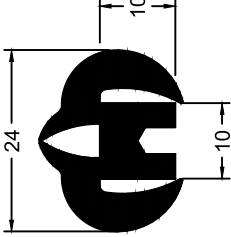
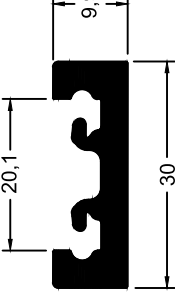
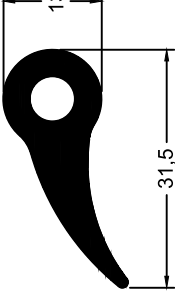
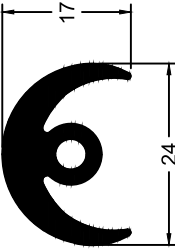
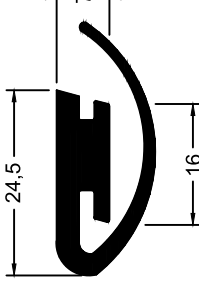
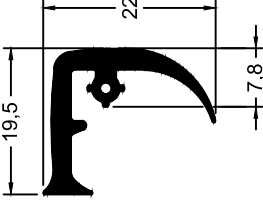
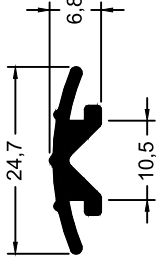
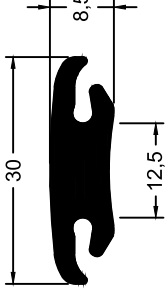
<p>CIA 16509*</p> 	<p>CIA 16570*</p> 	<p>CIA 17124*</p> 	<p>CIA 17125*</p> 
<p>CIA 6506**</p> 	<p>CIA 6507**</p> 	<p>CIA 6463**</p> 	<p>CIA 6094**</p> 
<p>CIA 6256**</p> 	<p>CIA 6447**</p> 	<p>CIA 17419**</p> 	<p>CIA 16870**</p> 

CIA 6359**
CIA 7072 #

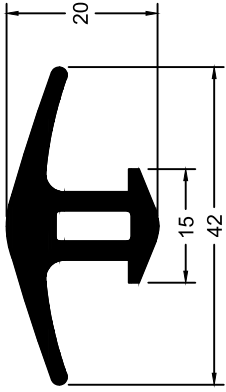

CIA 6478**

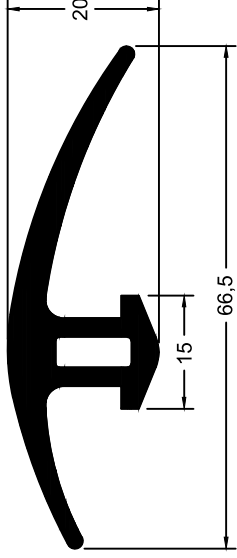

CIA 17198**

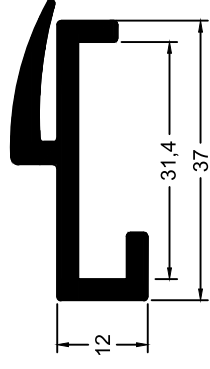

CIA 6438

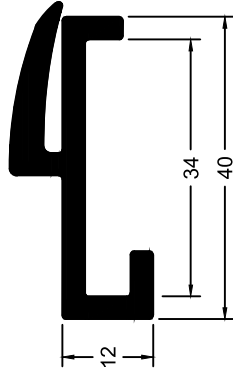

CIA 6422**

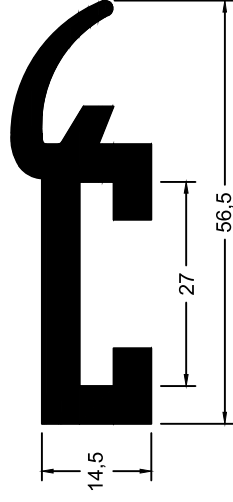

CIA 6437**

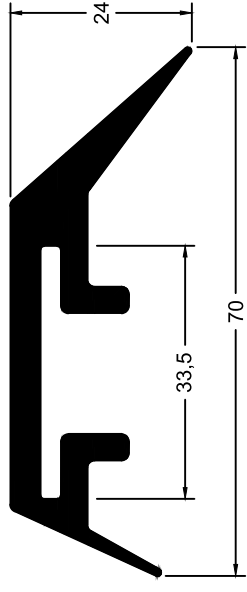

CIA 6108**

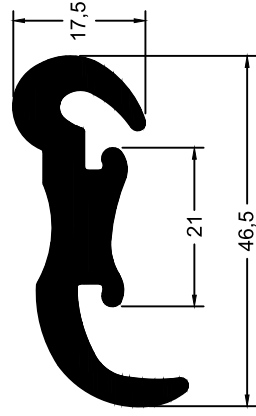

CIA 6192**

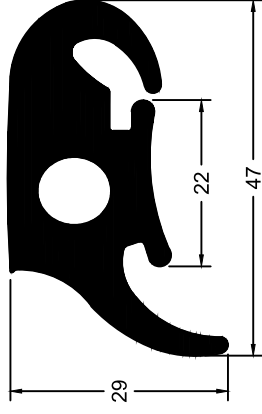

CIA 6483**

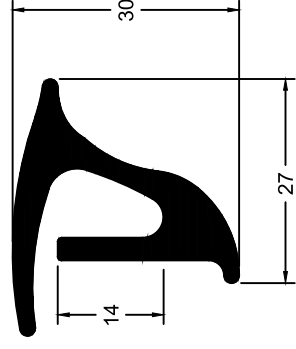

CIA 6397**

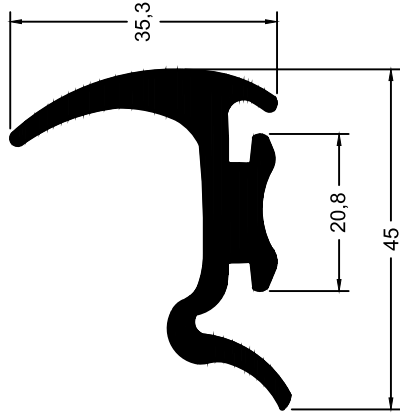

CIA 6488**

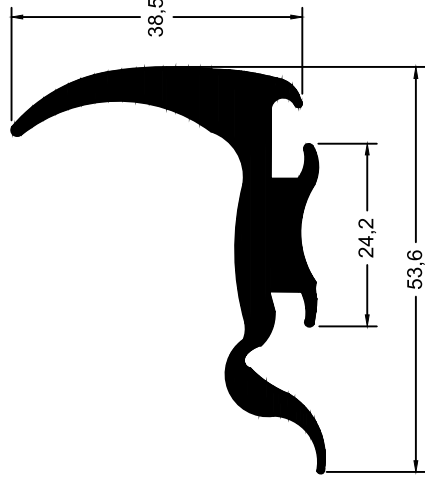

CIA 6210**

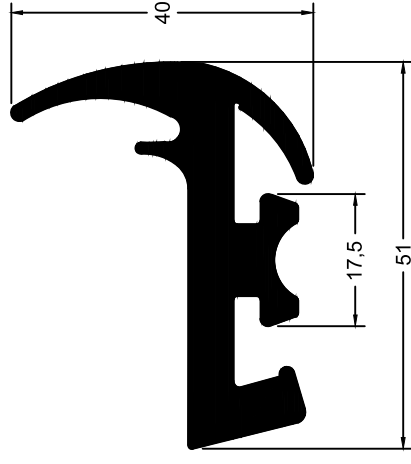

CIA 16311**

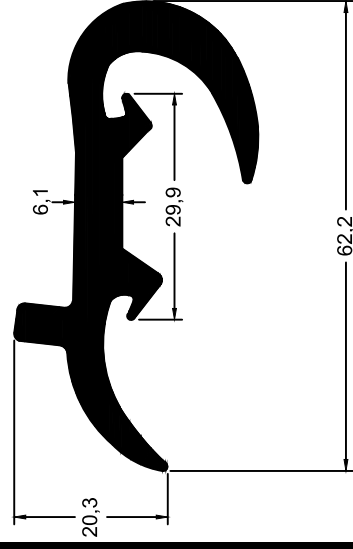

CIA 9118**

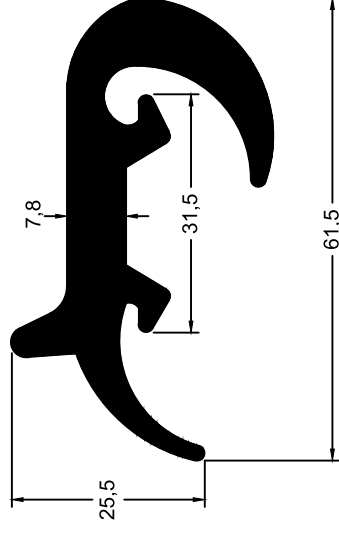

CIA 9134**

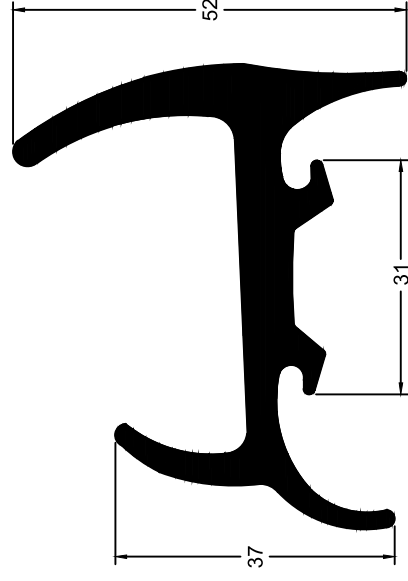

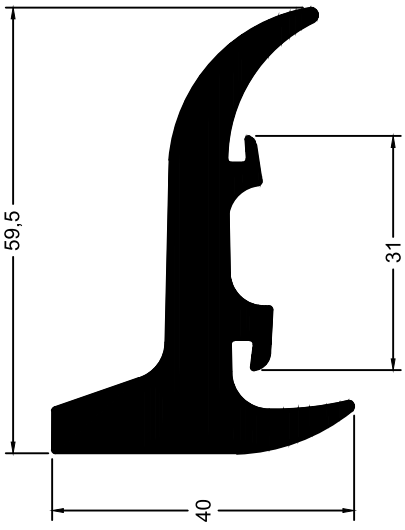
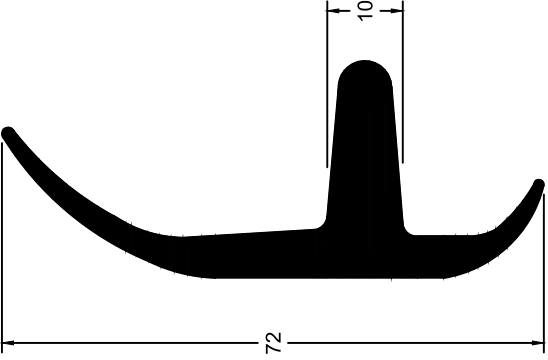
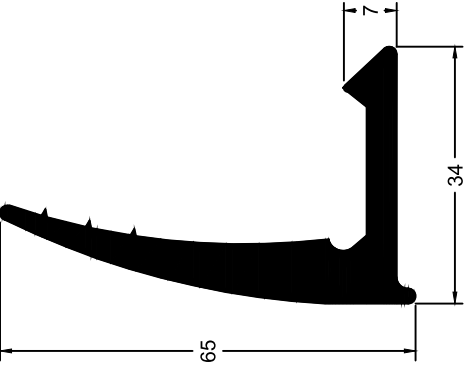
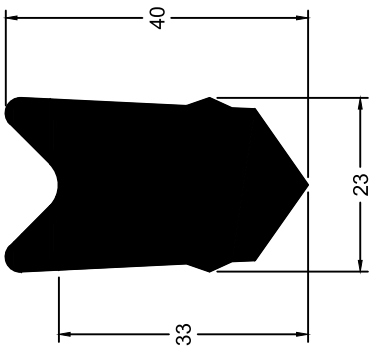
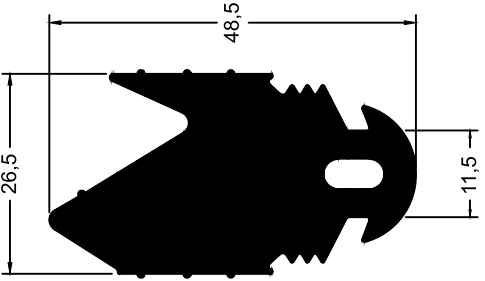
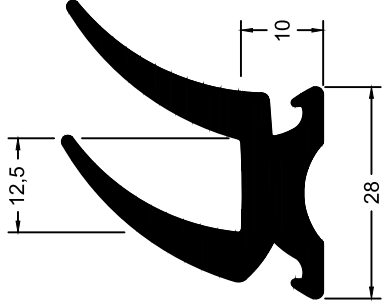
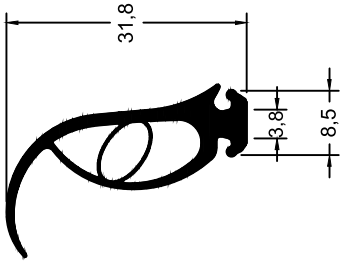
<p>CIA 9116**</p>  <p>40 59,5 31</p>	<p>CIA 15073**</p>  <p>72 10</p>	<p>CIA 9144**</p>  <p>65 34 7</p>
<p>CIA 17362**</p>  <p>33 40 23</p>	<p>CIA 6367*</p>  <p>26,5 48,5 11,5</p>	<p>CIA 6341**</p>  <p>12,5 28 10</p>
<p>CIA 15127#</p>  <p>31,8 8,8 8,5</p>		

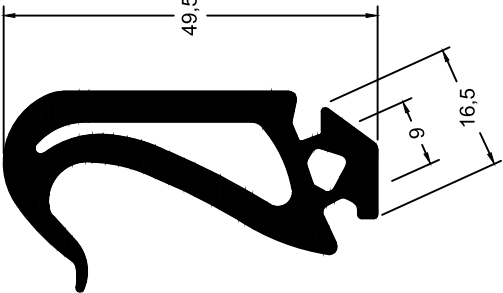
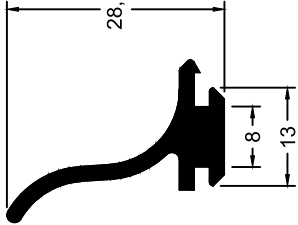
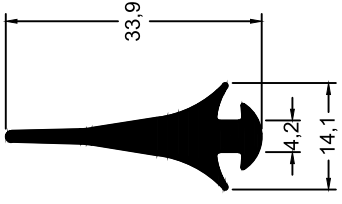
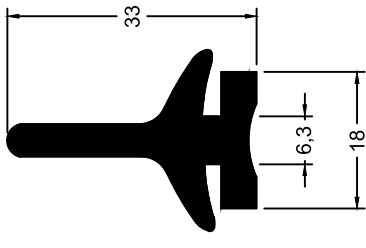
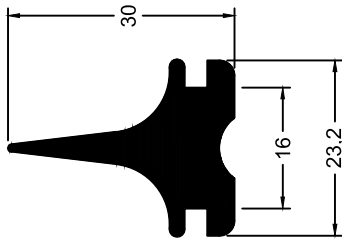
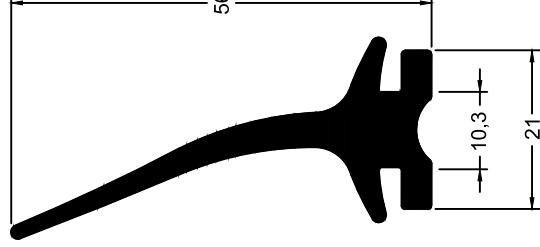
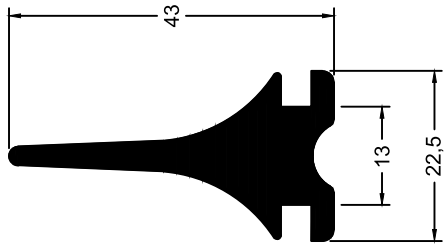
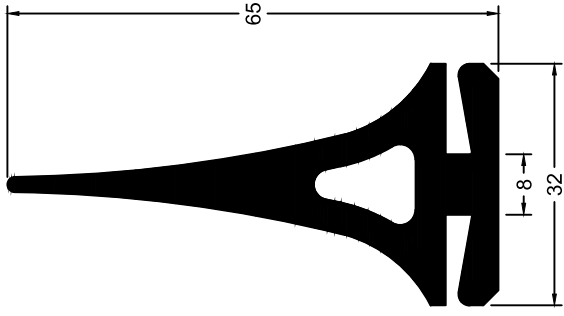
<p>CIA 6099</p> 	<p>CIA 16535**</p> 	<p>CIA 16823**</p> 	<p>CIA 6088**</p> 
<p>CIA 6481**</p> 	<p>CIA 6407</p> 	<p>CIA 7021 #</p> 	<p>CIA 9117**</p> 

CIA 7073#

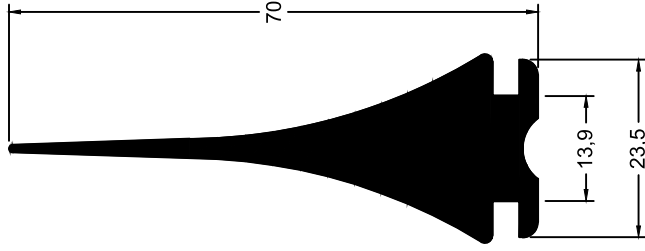

CIA 7022 #

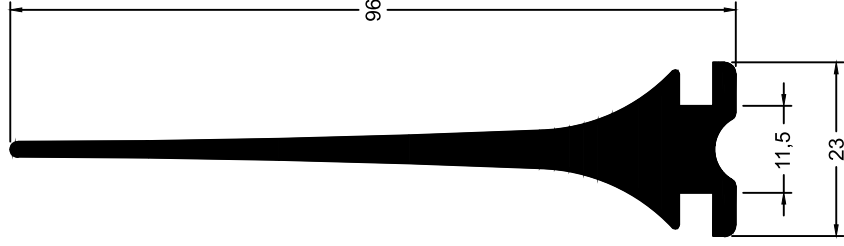

CIA 15404 #

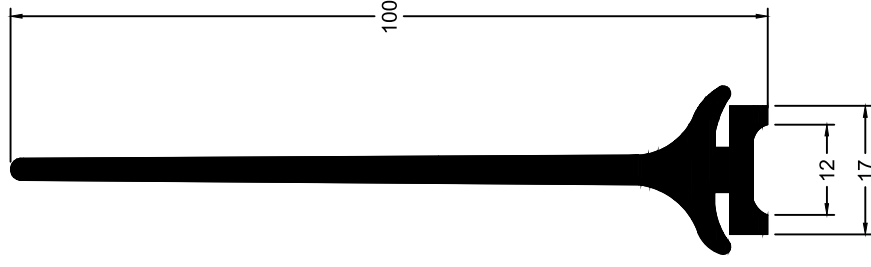

CIA 17400**

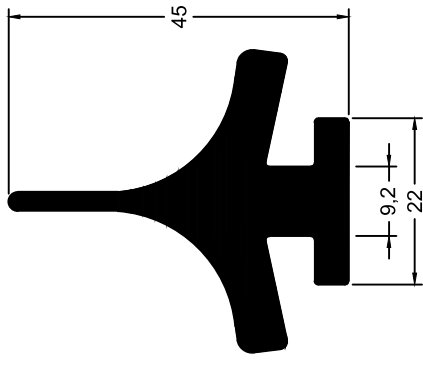

CIA 9154**

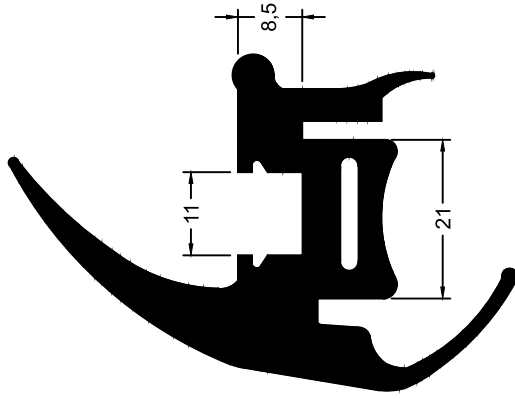

<p>CIA 6328</p>	<p>CIA 6059</p>	<p>CIA 6163</p>	<p>CIA 6247</p>
<p>CIA 6491**</p>	<p>CIA 6346**</p>	<p>CIA 6284**</p>	<p>CIA 6312</p>

<p>CIA 6285**</p>	<p>CIA 6446**</p>	<p>CIA 6451**</p>	<p>CIA 9124**</p>
<p>CIA 6285**</p>	<p>CIA 6446**</p>	<p>CIA 14943**</p>	<p>CIA 6362</p>

CIA 9132**

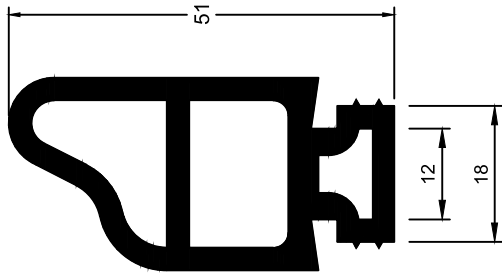

CIA 6213

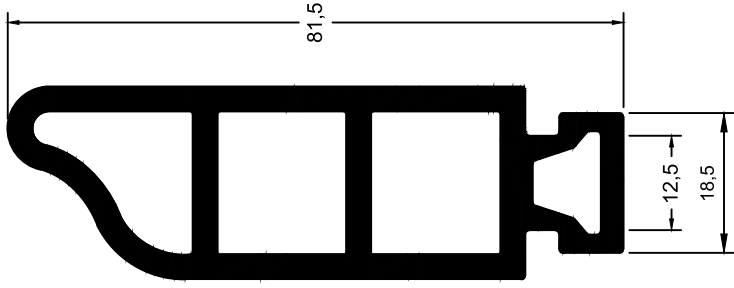

CIA 6219

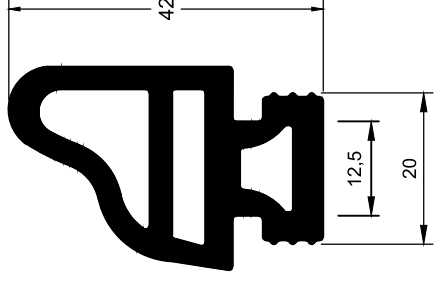

CIA 6411**

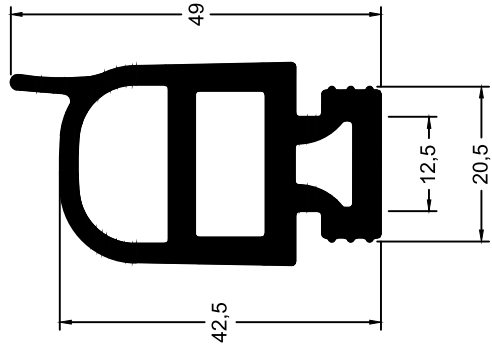

CIA 6208

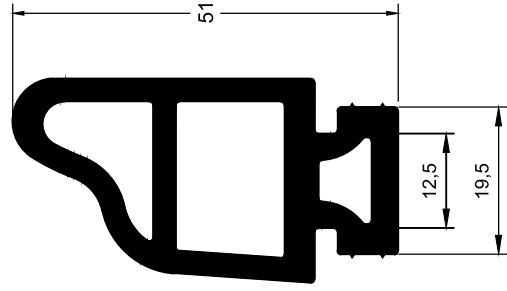

CIA 6380**

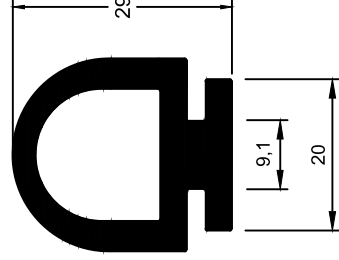

CIA 6092

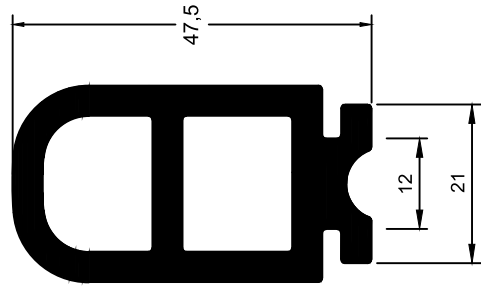

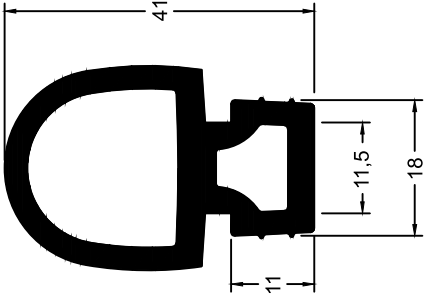
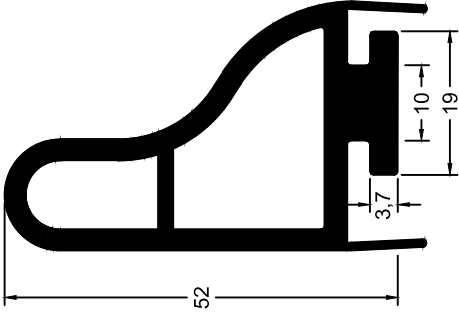
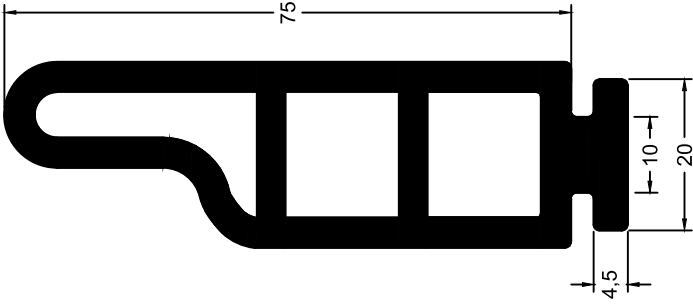
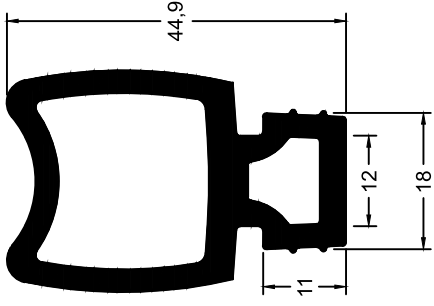
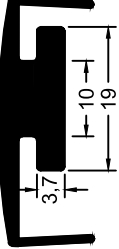
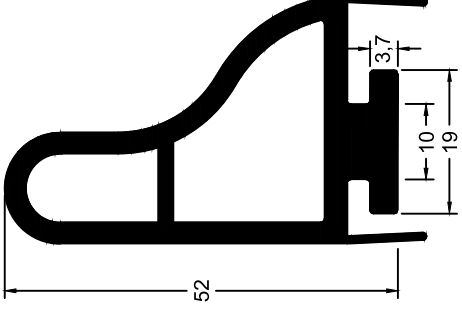
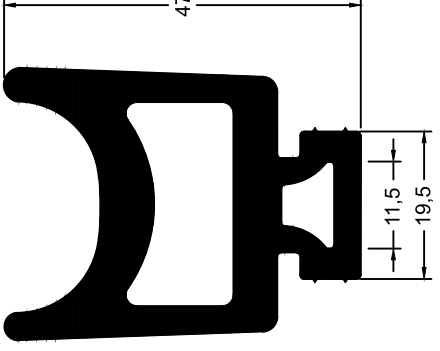
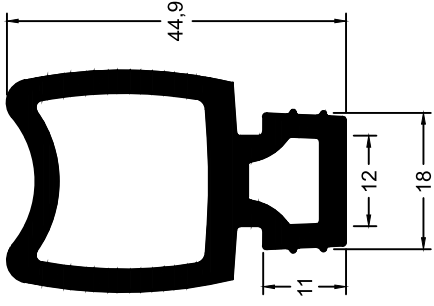
<p>CIA 6500**</p> 	<p>CIA 15825**</p> 	<p>CIA 16031**</p> 	<p>CIA 16496**</p> 
<p>CIA 15827**</p> 	<p>CIA 15826**</p> 	<p>CIA 15075**</p> 	<p>CIA 16496**</p> 

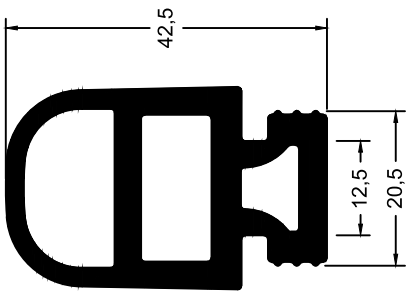
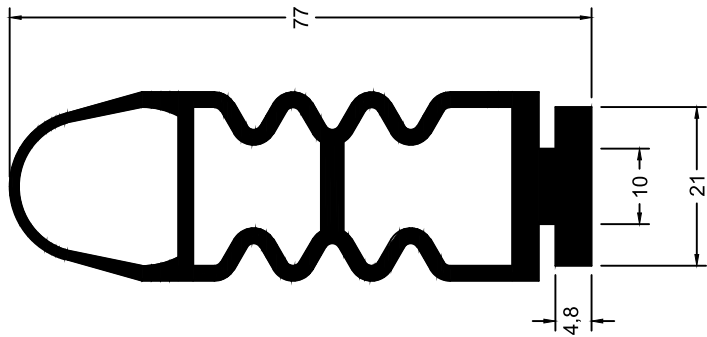
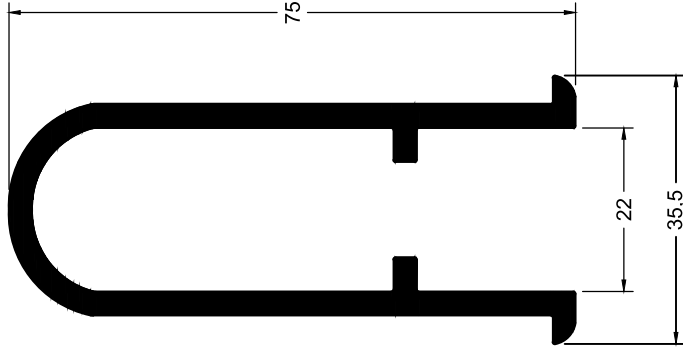
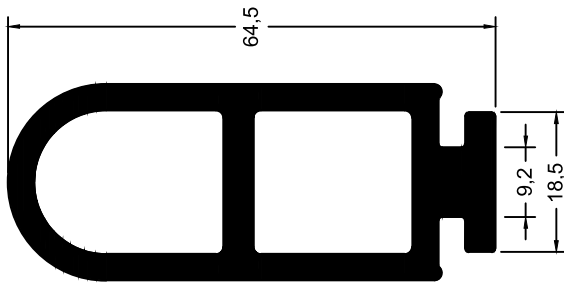
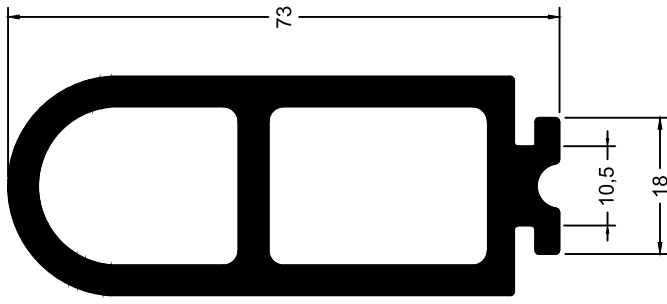
<p>CIA 6421**</p> 	<p>CIA 6487**</p> 	<p>CIA 6165</p> 	<p>CIA 6122**</p> 	<p>CIA 6077**</p> 
--	---	--	---	---

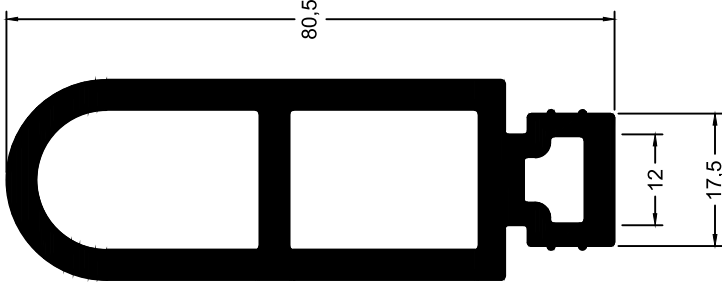
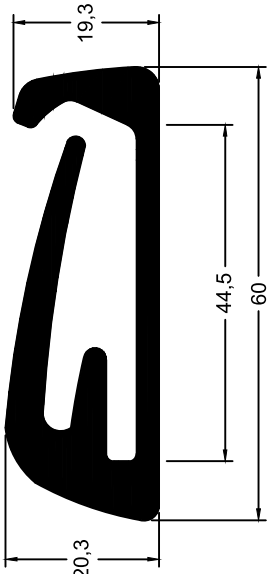
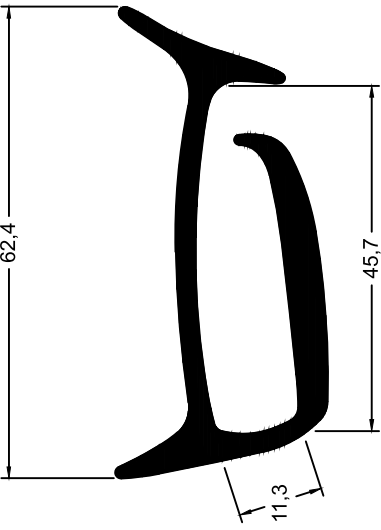
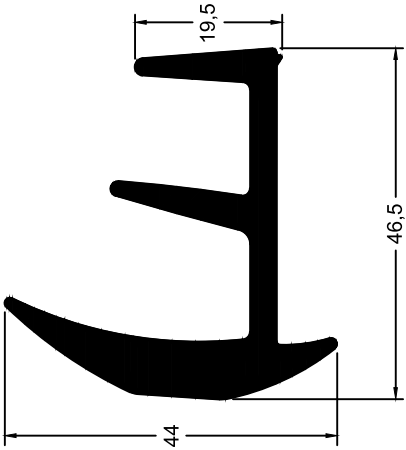
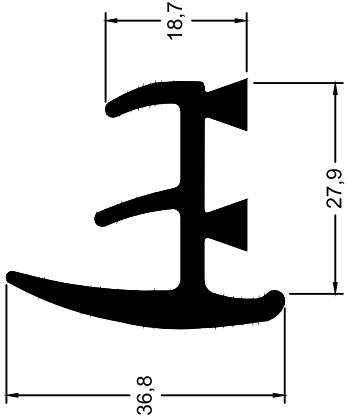
<p>CIA 6363</p> 	<p>CIA 16555**</p> 	<p>CIA 16742 #</p> 
<p>CIA 6177**</p> 	<p>CIA 16643**</p> 	

CIA 6162**

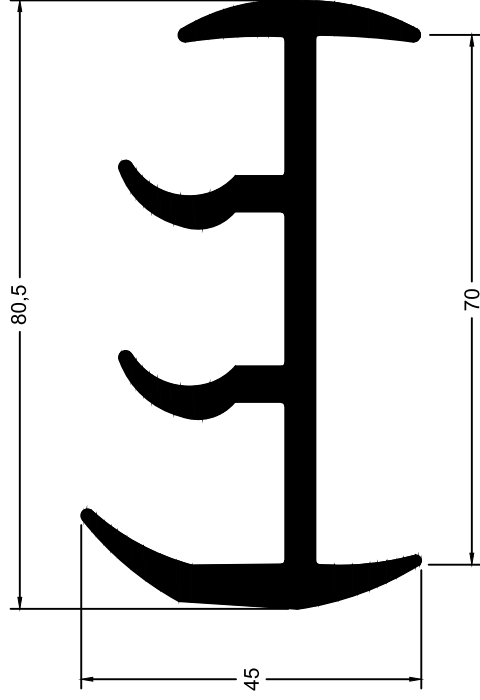

CIA 16857**

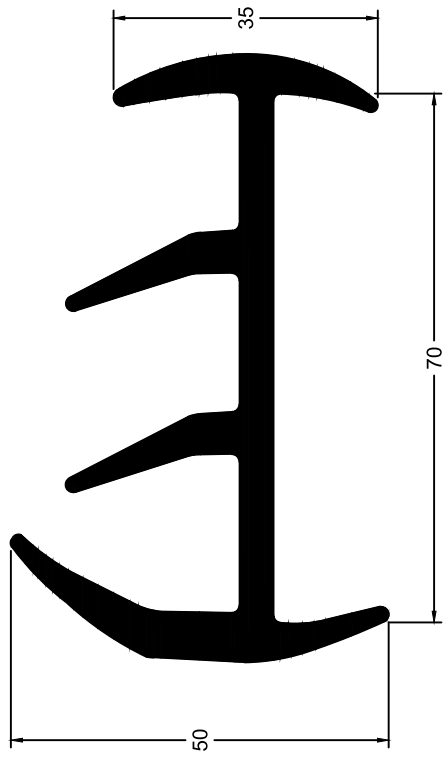

CIA 6046**

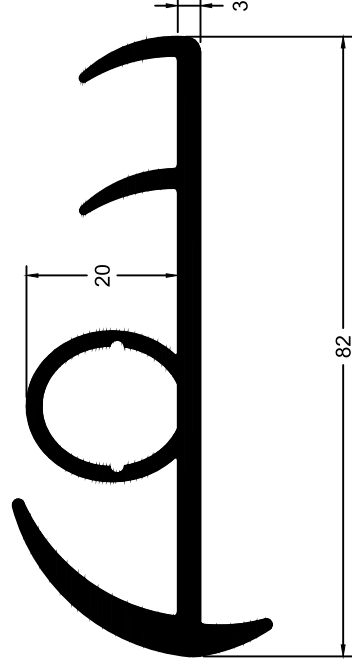

CIA 16803**

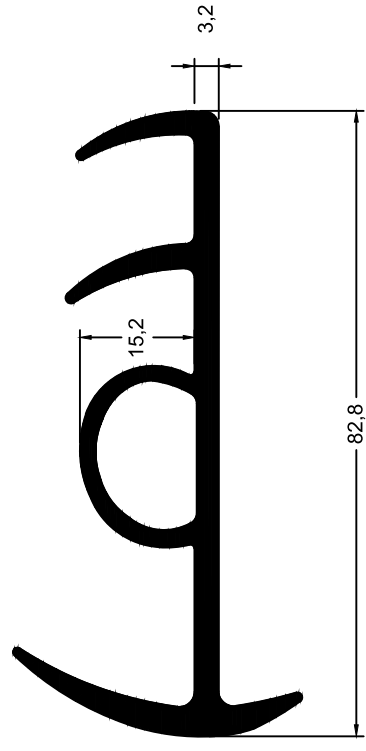

CIA 16633 #

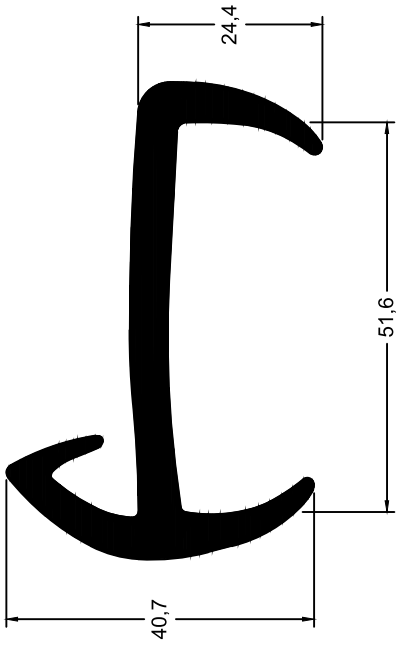

CIA 6369 #

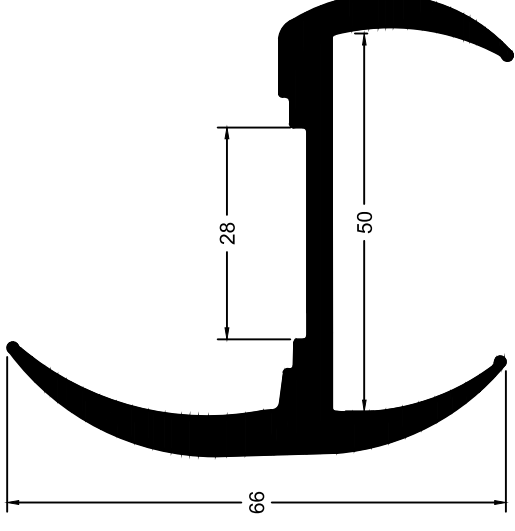

CIA 7029 #

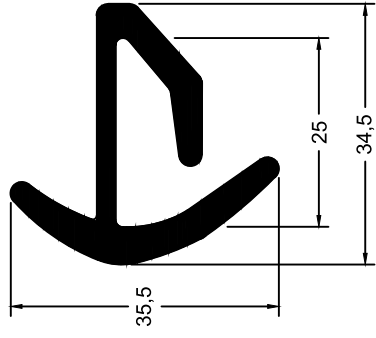

CIA 6340**

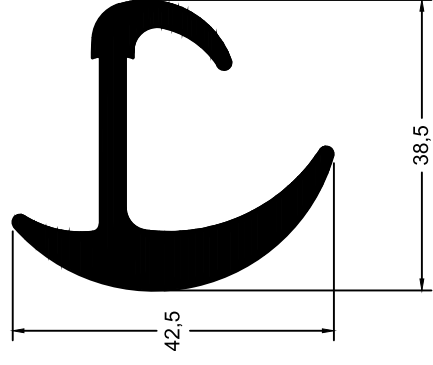

CIA 6339**

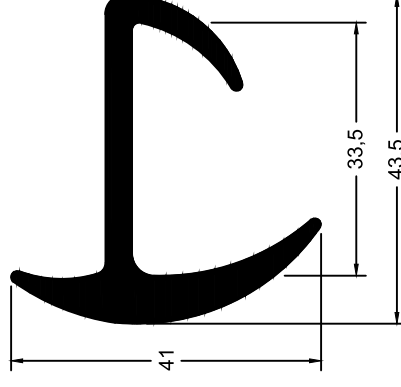

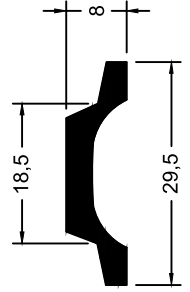
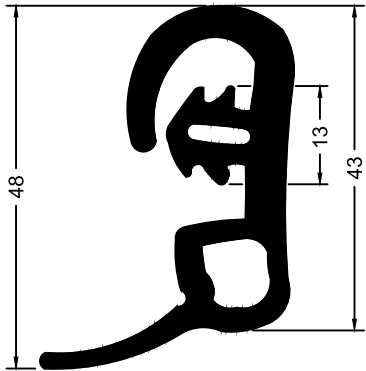
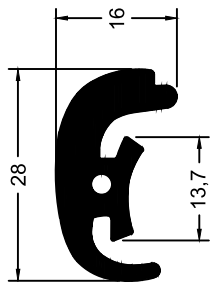
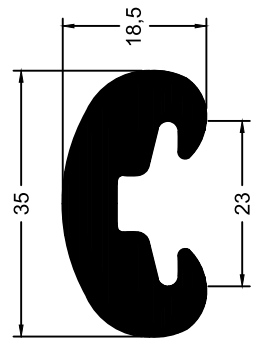
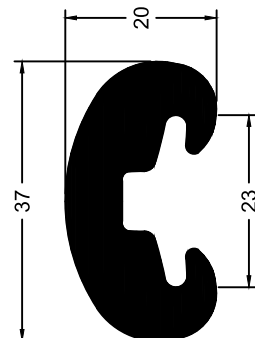
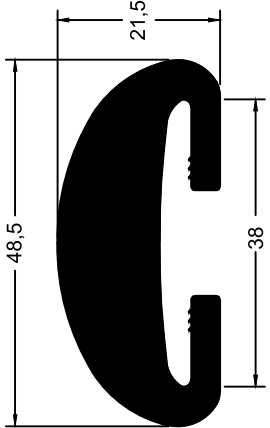
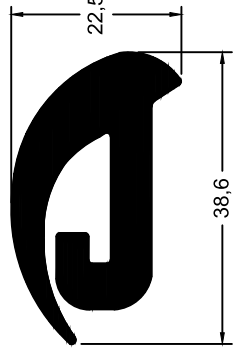
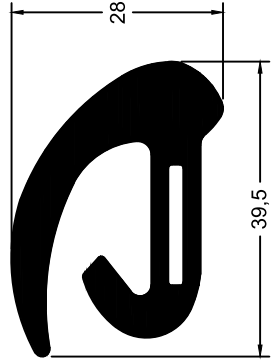
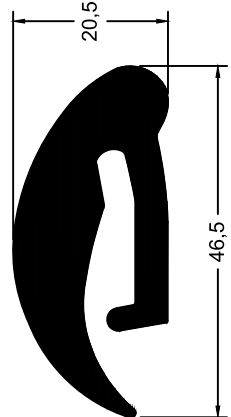
<p>CIA 6492**</p>  <p>Dimensions: 18,5 (width), 29,5 (height), 8 (thickness)</p>	<p>CIA 14065**</p>  <p>Dimensions: 48 (width), 43 (height), 13 (thickness)</p>	<p>CIA 6221**</p>  <p>Dimensions: 28 (width), 16 (height), 13,7 (thickness)</p>
<p>CIA 6050**</p>  <p>Dimensions: 35 (width), 18,5 (height), 23 (thickness)</p>	<p>CIA 6100**</p>  <p>Dimensions: 37 (width), 20 (height), 23 (thickness)</p>	<p>CIA 6287**</p>  <p>Dimensions: 48,5 (width), 21,5 (height), 38 (thickness)</p>
<p>CIA 6097**</p>  <p>Dimensions: 38,6 (width), 22,5 (height)</p>	<p>CIA 6345**</p>  <p>Dimensions: 28 (width), 39,5 (height)</p>	<p>CIA 6051**</p>  <p>Dimensions: 20,5 (width), 46,5 (height)</p>

CIA 6031

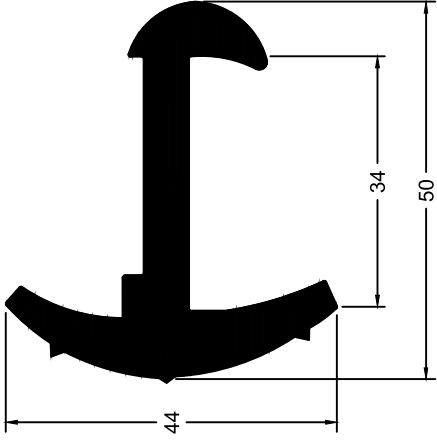

CIA 6239**

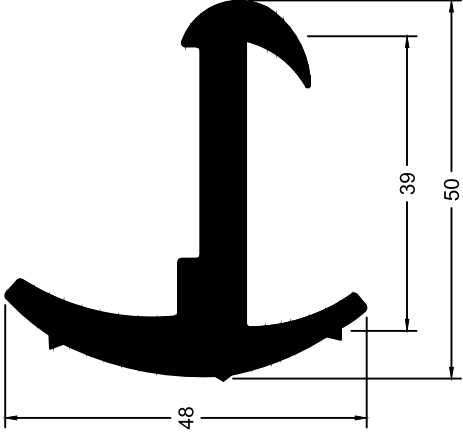

CIA 6196**

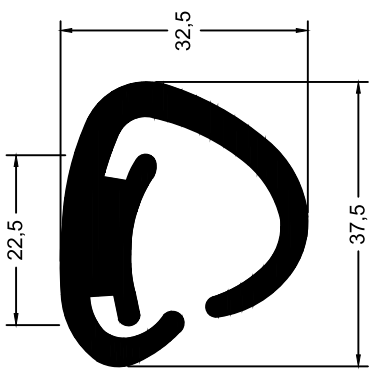

CIA 6493**

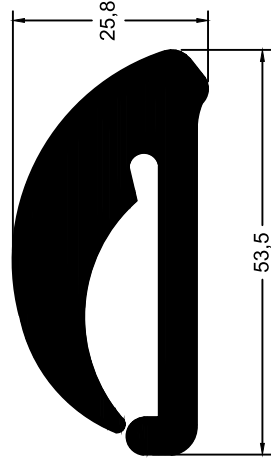

CIA 6090**

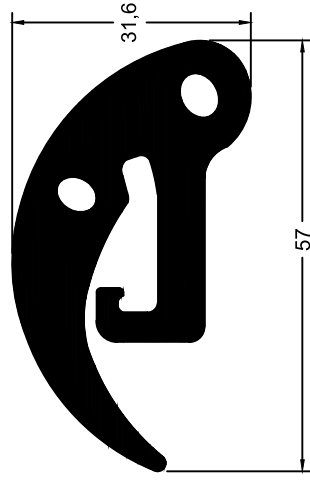

CIA 6203**

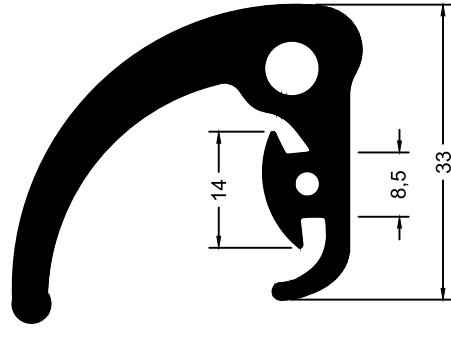

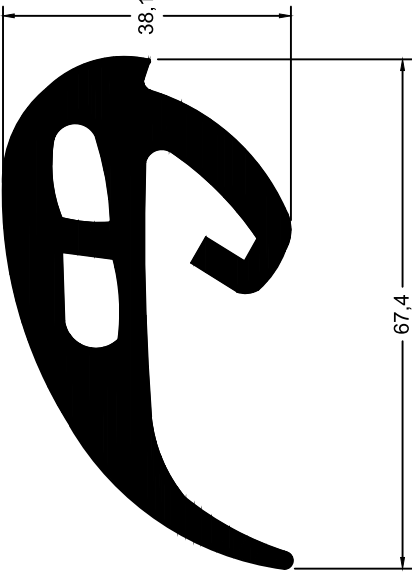
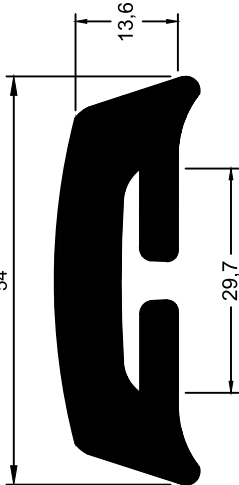
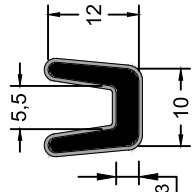
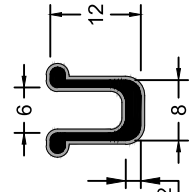
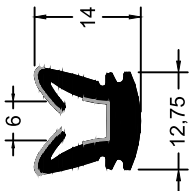
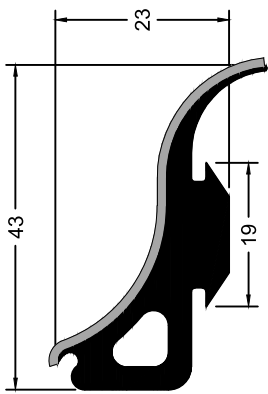
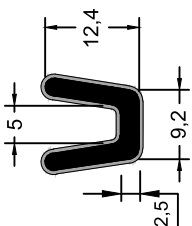
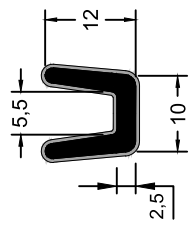
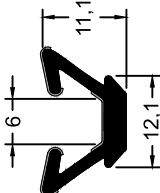
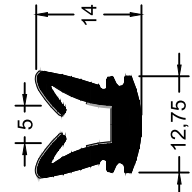
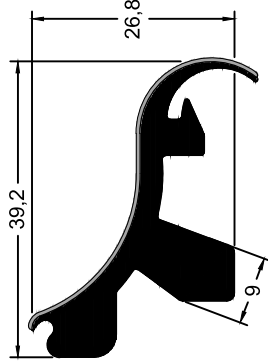
<p>CIA 14842**</p>  <p>67,4 38,1</p>	<p>CIA 91756**</p>  <p>54 29,7 13,6</p>
<p>CIA 6375 (canaleta revestida)</p>  <p>5,5 12 10 3</p>	<p>CIA 6508** (canaleta revestida)</p>  <p>6 12 8 2</p>
<p>CIA 6351** (canaleta flocada)</p>  <p>6 14 12,75</p>	<p>CIA 9149** (Flocado)</p>  <p>43 23 19</p>
<p>CIA 6501 (canaleta revestida)</p>  <p>5 12,4 9,2 2,5</p>	<p>CIA 6404 (canaleta revestida)</p>  <p>5,5 12 10 2,5</p>
<p>CIA 16952** (canaleta flocada)</p>  <p>6 11,1 12,1 11,1</p>	<p>CIA 6502** (canaleta flocada)</p>  <p>5 14 12,75</p>
<p>CIA 16757** (Flocado)</p>  <p>39,2 26,8 9</p>	

<p>CIA 9065**</p>	<p>CIA 9108</p>	<p>CIA 9015**</p>	<p>CIA 9047**</p>
<p>CIA 9085**</p>	<p>CIA 16843**</p>	<p>CIA 9014**</p>	<p>CIA 9146**</p>
<p>CIA 9125**</p>	<p>CIA 9018**</p>	<p>CIA 9048**</p>	<p>CIA 9004**</p>
<p>CIA 9122**</p>	<p>CIA 9036**</p>	<p>CIA 9035**</p>	<p>CIA 6475**</p>

<p>CIA 9037**</p>	<p>CIA 9038**</p>	<p>CIA 9033**</p>	<p>CIA 9034**</p>
<p>CIA 9012**</p>	<p>CIA 9056**</p>	<p>CIA 15875</p>	<p>CIA 14841**</p>
<p>CIA 9055**</p>	<p>CIA 9084**</p>	<p>CIA 9059**</p>	<p>CIA 9090**</p>
<p>CIA 9133**</p>	<p>CIA 9039**</p>	<p>CIA 9151**</p>	<p>CIA 9089**</p>

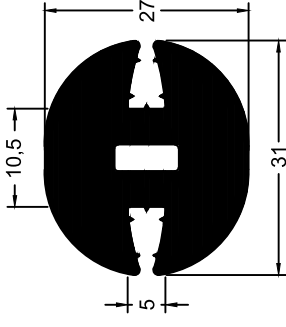
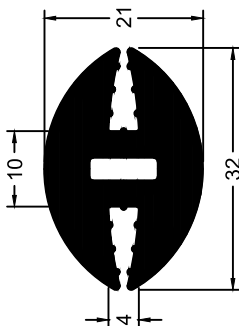
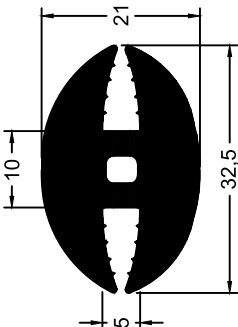
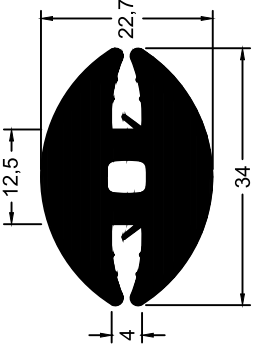
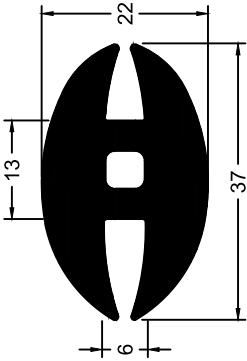
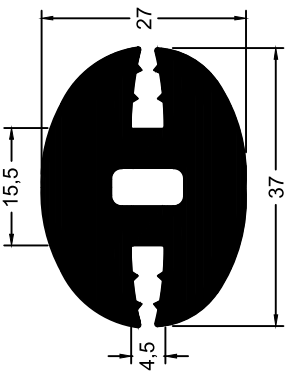
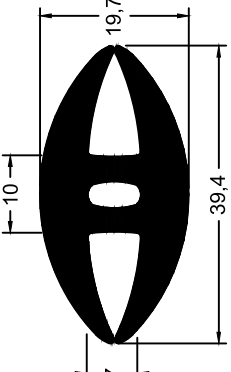
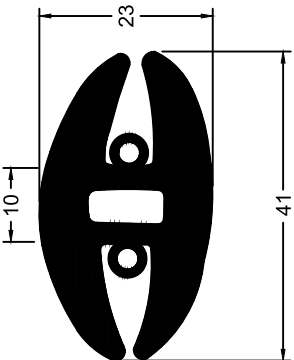
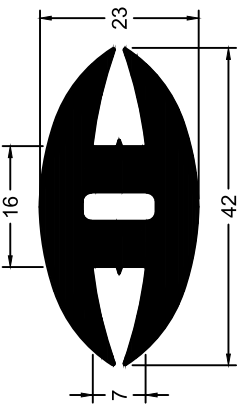
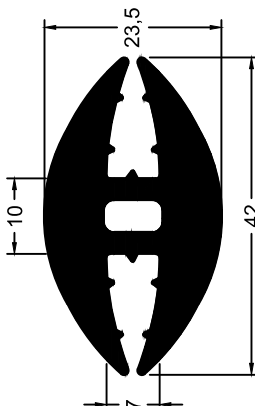
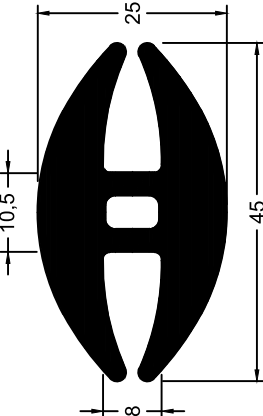
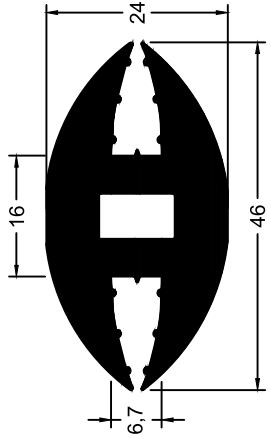
<p>CIA 9002**</p>  <p>Dimensions: 10,5 (width), 27 (height), 31 (total width), 5 (flange width)</p>	<p>CIA 9097**</p>  <p>Dimensions: 10 (width), 21 (height), 32 (total width), 4 (flange width)</p>	<p>CIA 9037**</p>  <p>Dimensions: 10 (width), 21 (height), 32,5 (total width), 5 (flange width)</p>	<p>CIA 9157**</p>  <p>Dimensions: 12,5 (width), 22,7 (height), 34 (total width), 4 (flange width)</p>
<p>CIA 9007**</p>  <p>Dimensions: 13 (width), 22 (height), 37 (total width), 6 (flange width)</p>	<p>CIA 9052**</p>  <p>Dimensions: 15,5 (width), 27 (height), 37 (total width), 4,5 (flange width)</p>	<p>CIA 14803**</p>  <p>Dimensions: 10 (width), 19,7 (height), 39,4 (total width), 7 (flange width)</p>	<p>CIA 15974**</p>  <p>Dimensions: 10 (width), 23 (height), 41 (total width)</p>
<p>CIA 9001**</p>  <p>Dimensions: 16 (width), 23 (height), 42 (total width), 7 (flange width)</p>	<p>CIA 9029**</p>  <p>Dimensions: 10 (width), 23,5 (height), 42 (total width), 7 (flange width)</p>	<p>CIA 9032**</p>  <p>Dimensions: 10,5 (width), 25 (height), 45 (total width), 8 (flange width)</p>	<p>CIA 9112**</p>  <p>Dimensions: 16 (width), 24 (height), 46 (total width), 6,7 (flange width)</p>

<p>CIA 16515**</p>	<p>CIA 9070**</p>	<p>CIA 9103**</p>
<p>CIA 9138**</p>	<p>CIA 9054**</p>	<p>CIA 9016**</p>
<p>CIA 9026**</p>	<p>CIA 9063**</p>	<p>CIA 9119**</p>

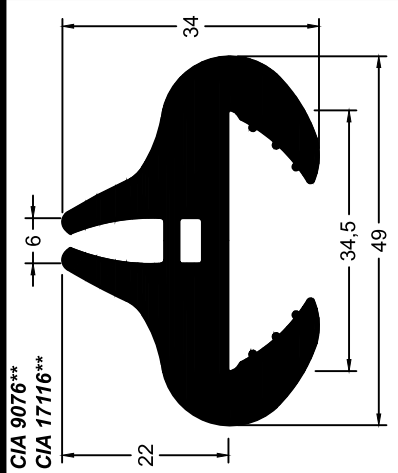
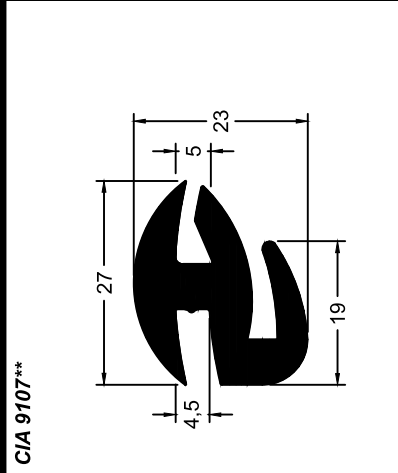
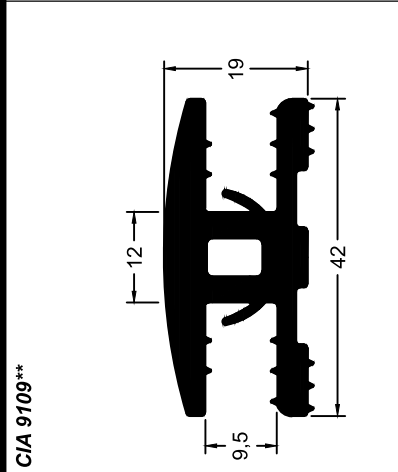
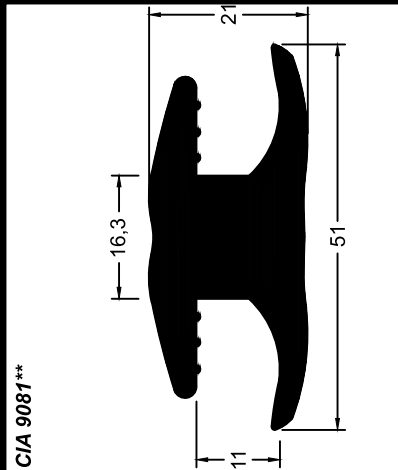
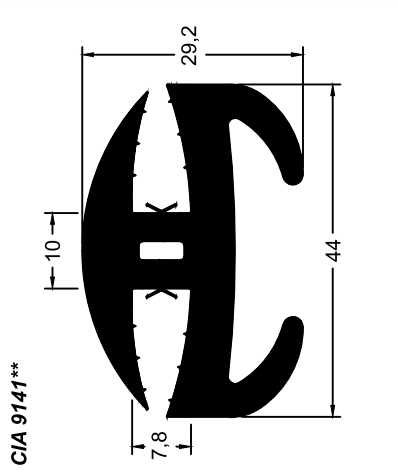
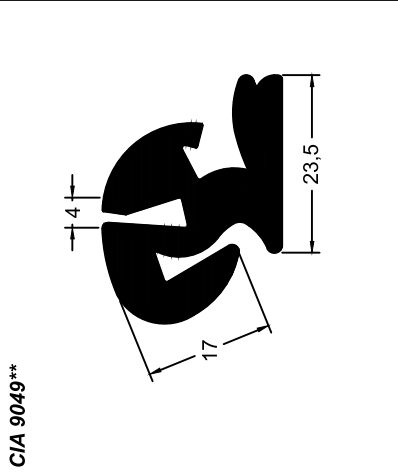
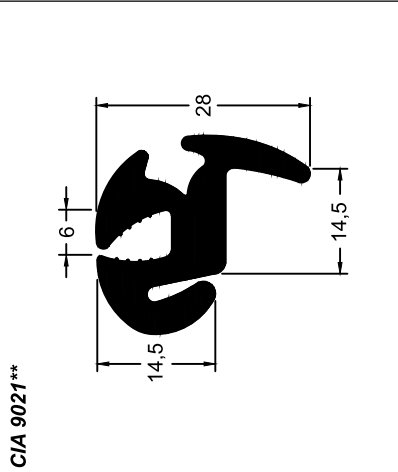
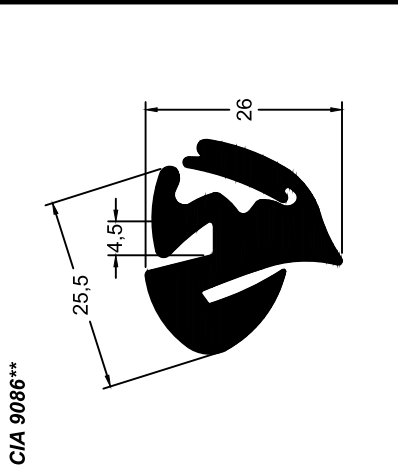
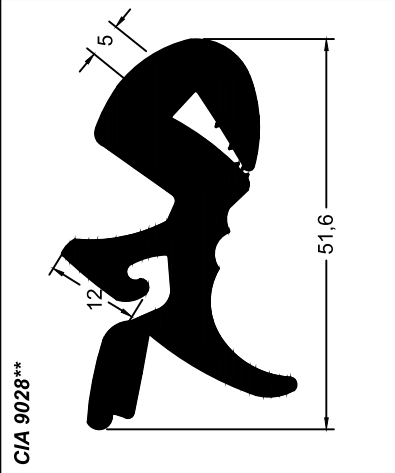
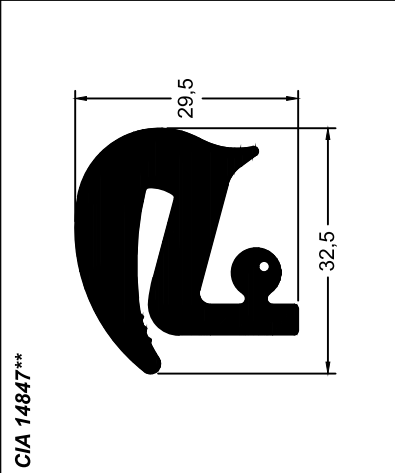
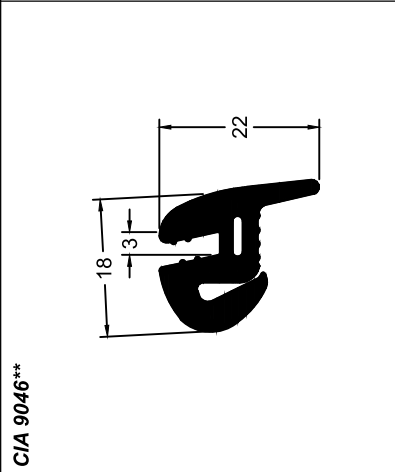
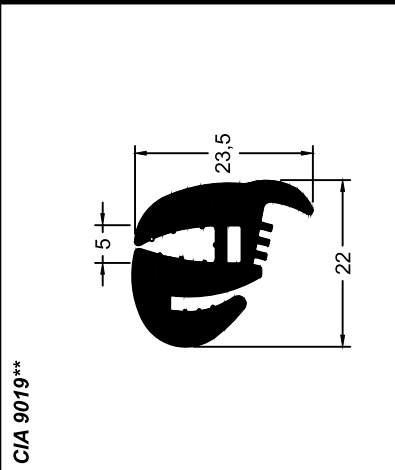
<p>CIA 9076** CIA 17116**</p>  <p>Dimensions: 22, 6, 34, 34,5, 49</p>	<p>CIA 9107**</p>  <p>Dimensions: 4,5, 27, 5, 23, 19</p>	<p>CIA 9109**</p>  <p>Dimensions: 9,5, 12, 19, 42</p>	<p>CIA 9081**</p>  <p>Dimensions: 11, 16,3, 21, 51</p>
<p>CIA 9141**</p>  <p>Dimensions: 7,8, 10, 29,2, 44</p>	<p>CIA 9049**</p>  <p>Dimensions: 4, 17, 23,5</p>	<p>CIA 9021**</p>  <p>Dimensions: 6, 14,5, 28, 14,5</p>	<p>CIA 9086**</p>  <p>Dimensions: 14,5, 25,5, 26</p>
<p>CIA 9028**</p>  <p>Dimensions: 12, 5, 51,6</p>	<p>CIA 14847**</p>  <p>Dimensions: 29,5, 32,5</p>	<p>CIA 9046**</p>  <p>Dimensions: 18, 3, 22</p>	<p>CIA 9019**</p>  <p>Dimensions: 5, 23,5, 22</p>

CIA 9143**

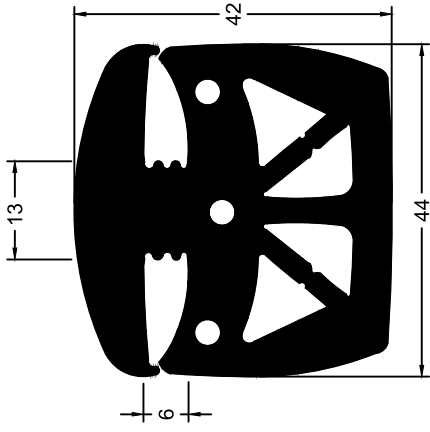

CIA 9075**

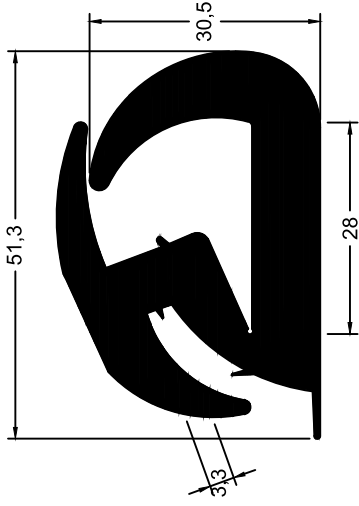

CIA 9077**

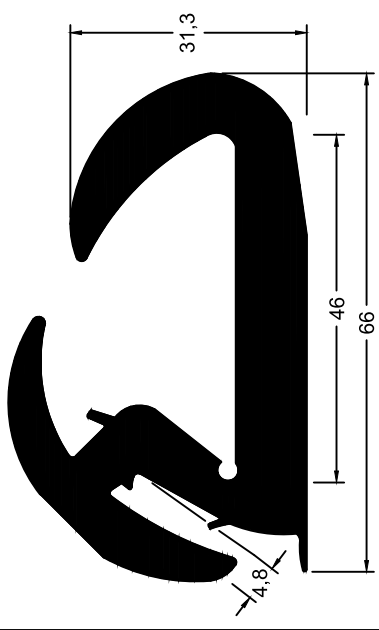

CIA 9080**

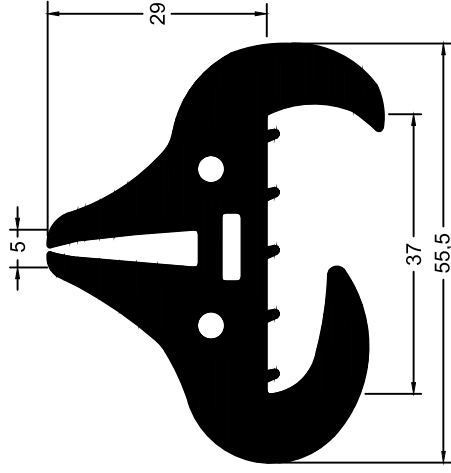

CIA 9073**

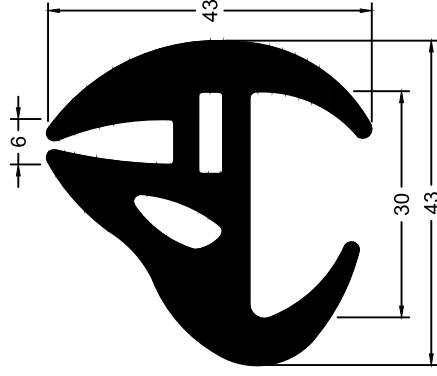

CIA 9095**

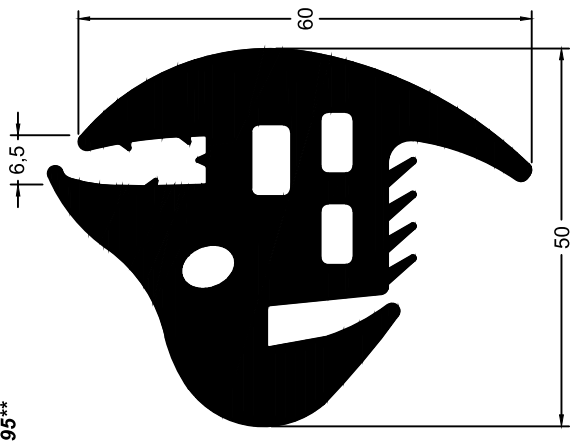

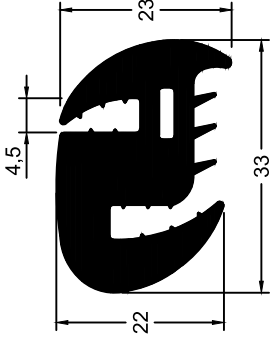
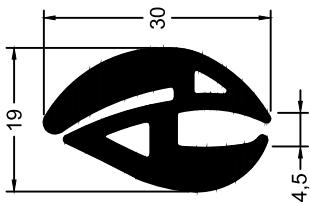
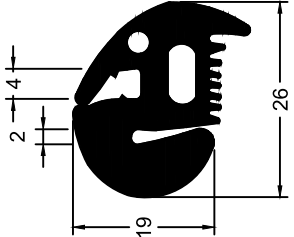
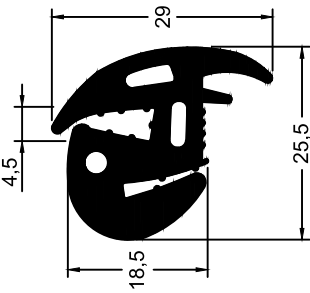
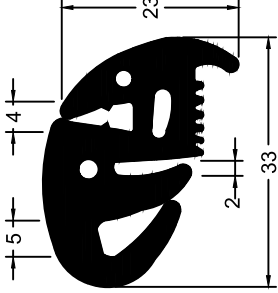
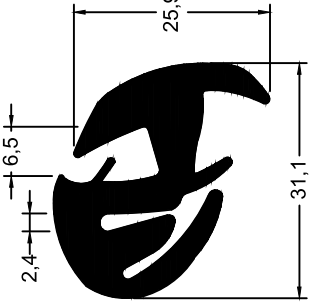
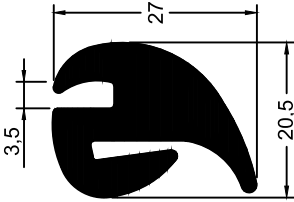
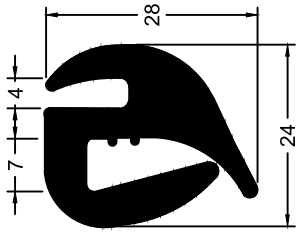
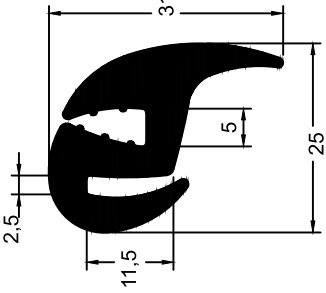
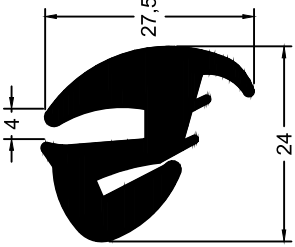
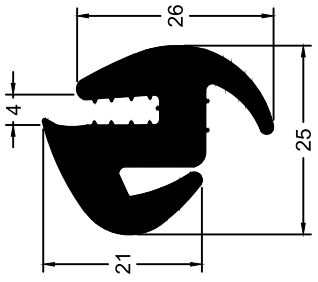
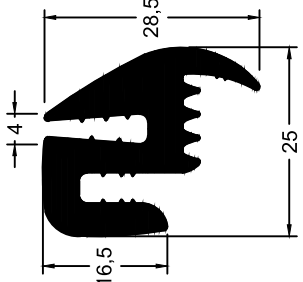
<p>CIA 9041**</p> 	<p>CIA 9045**</p> 	<p>CIA 14263**</p> 	<p>CIA 9066**</p> 
<p>CIA 14261**</p> 	<p>CIA 16622**</p> 	<p>CIA 9068**</p> 	<p>CIA 14199**</p> 
<p>CIA 9062</p> 	<p>CIA 9082**</p> 	<p>CIA 9025**</p> 	<p>CIA 9013**</p> 

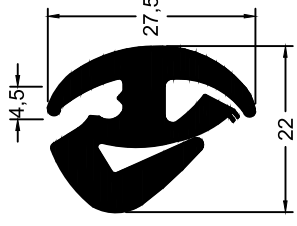
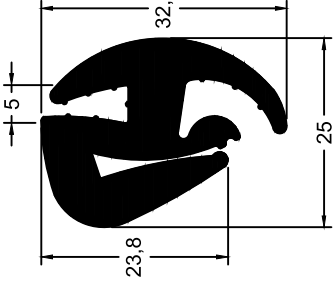
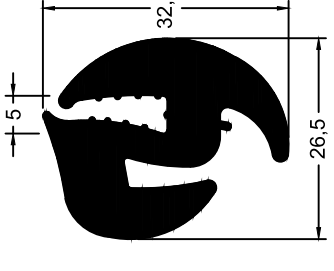
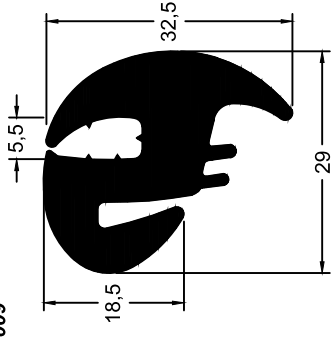
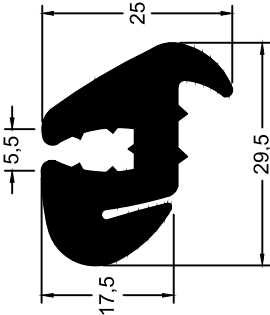
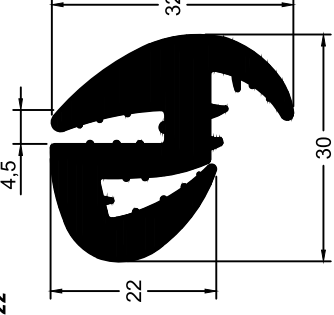
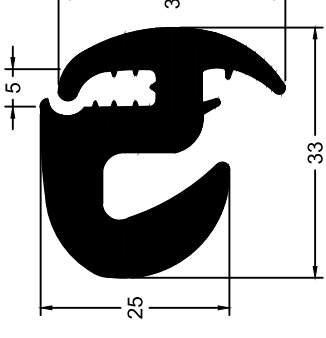
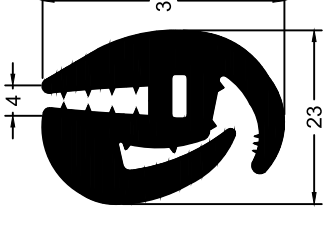
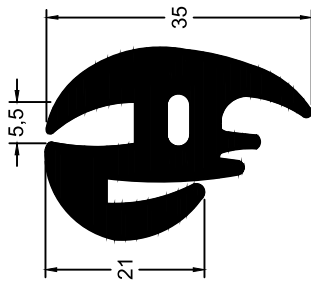
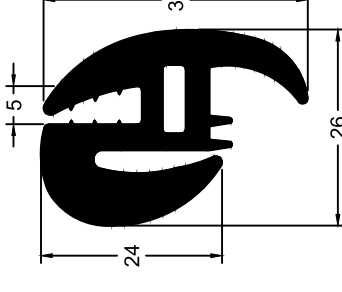
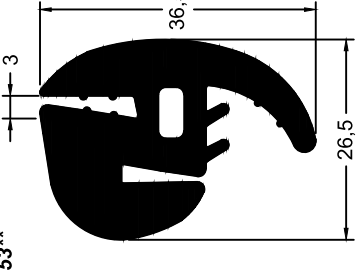
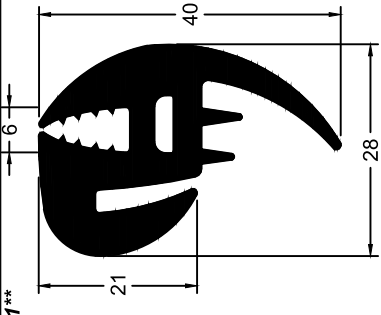
<p>CIA 9057**</p> 	<p>CIA 9094**</p> 	<p>CIA 9098**</p> 	<p>CIA 9009**</p> 
<p>CIA 9006**</p> 	<p>CIA 9022**</p> 	<p>CIA 9043**</p> 	<p>CIA 9044**</p> 
<p>CIA 9008**</p> 	<p>CIA 9074**</p> 	<p>CIA 9053**</p> 	<p>CIA 9011**</p> 

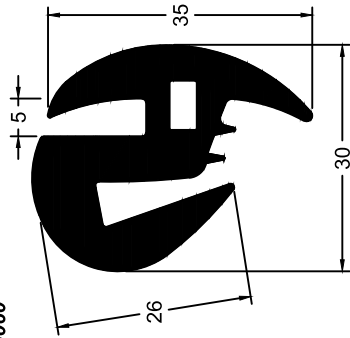
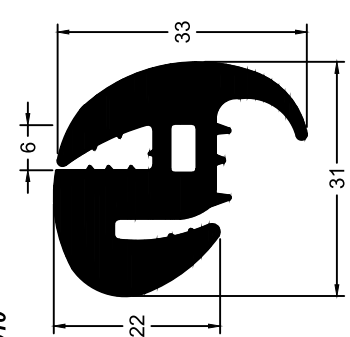
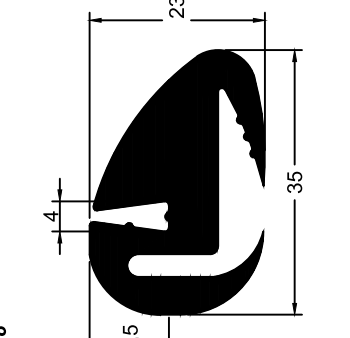
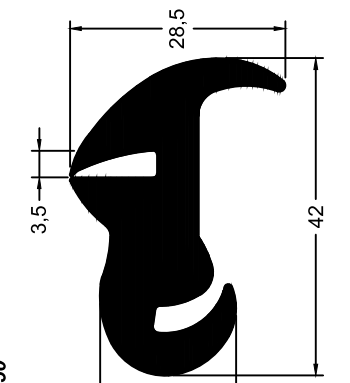
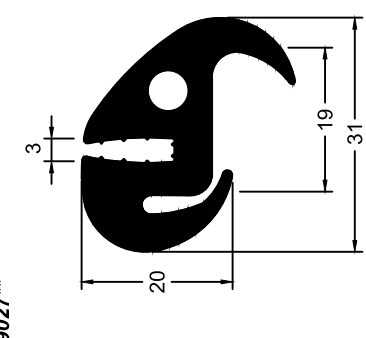
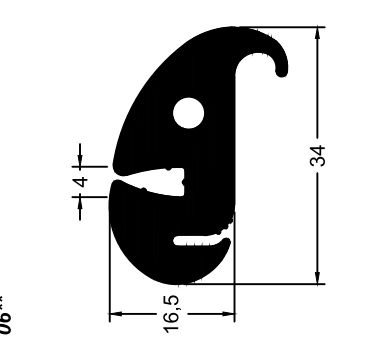
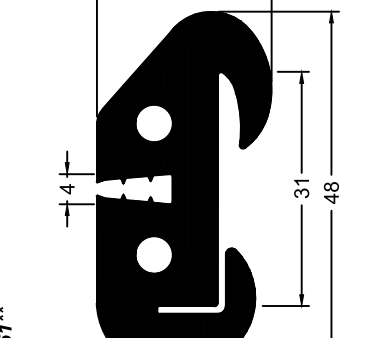
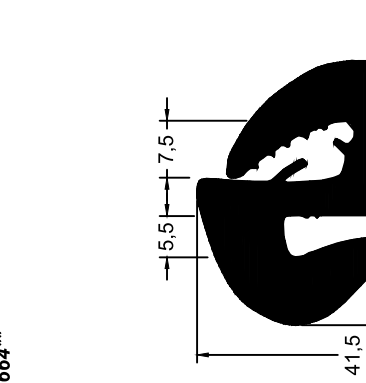
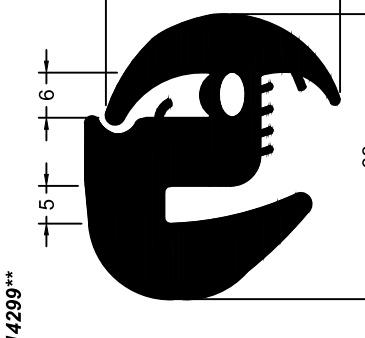
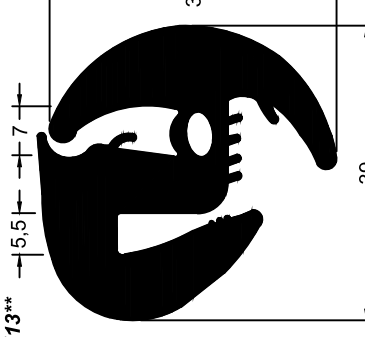
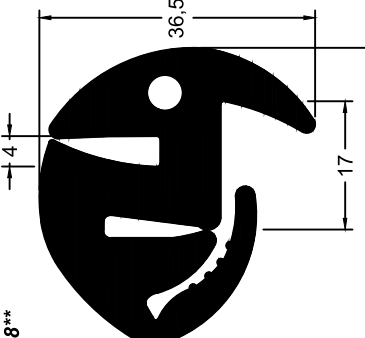
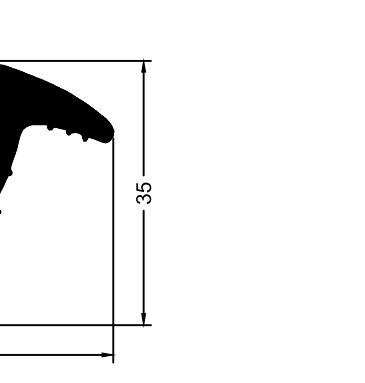
<p>CIA 9060**</p>  <p>5, 26, 30, 35</p>	<p>CIA 9010**</p>  <p>6, 22, 31, 33</p>	<p>CIA 9128**</p>  <p>4, 10,5, 23, 35</p>	<p>CIA 9050**</p>  <p>3,5, 18, 28,5, 42</p>
<p>CIA 9027**</p>  <p>3, 20, 19, 31</p>	<p>CIA 9106**</p>  <p>4, 16,5, 34, 34</p>	<p>CIA 9061**</p>  <p>4, 23, 31, 48</p>	<p>CIA 14664**</p>  <p>5,5, 7,5, 41,5, 35</p>
<p>CIA 14299**</p>  <p>5, 6, 31, 38</p>	<p>CIA 9113**</p>  <p>5,5, 7, 38, 39</p>	<p>CIA 9078**</p>  <p>4, 36,5, 17, 39</p>	<p>CIA 9066**</p>  <p>4, 36,5, 17, 39</p>

CIA 15973

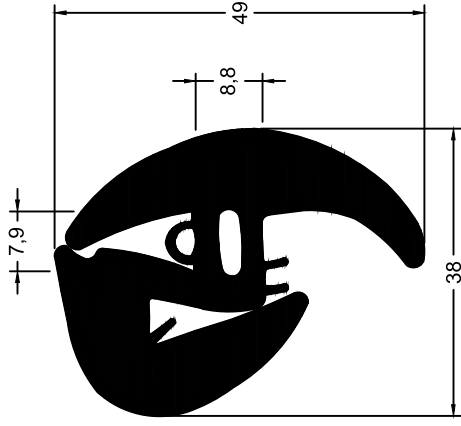

CIA 9079**

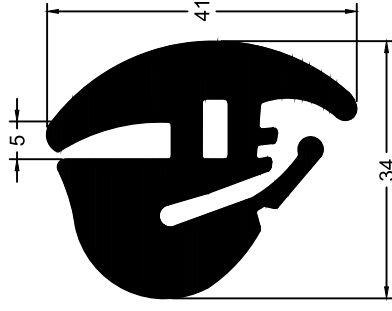

CIA 9005**

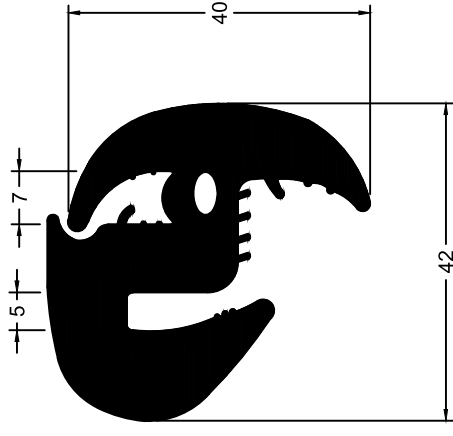

CIA 16845**

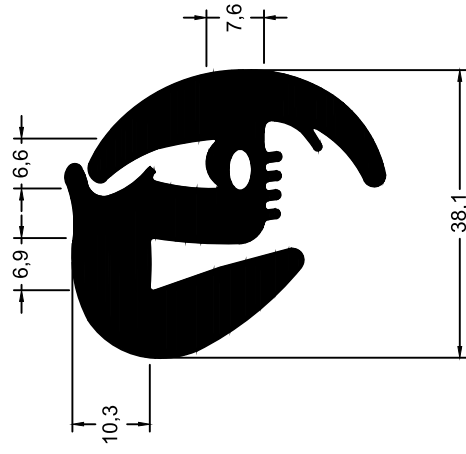

CIA 9142**

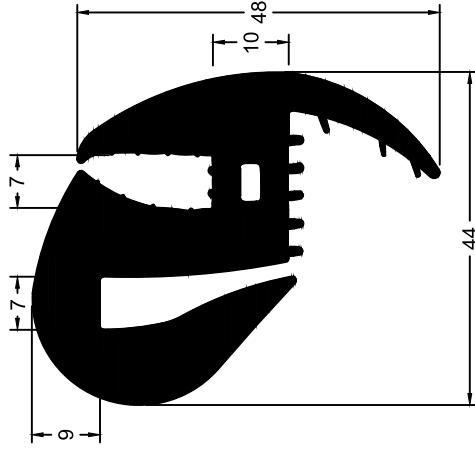

CIA 9111**

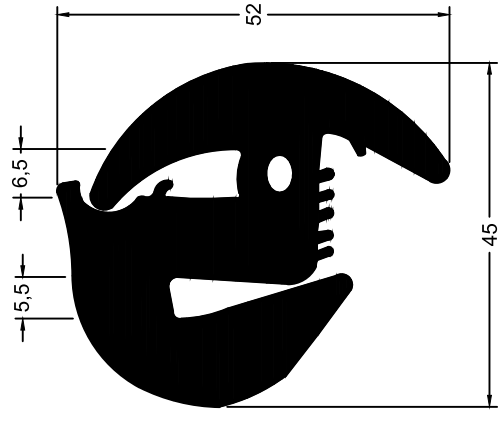

CIA 15031**

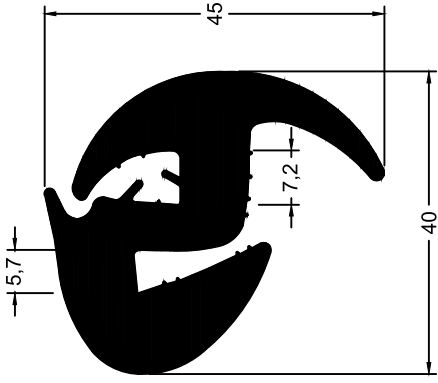

CIA 15082**

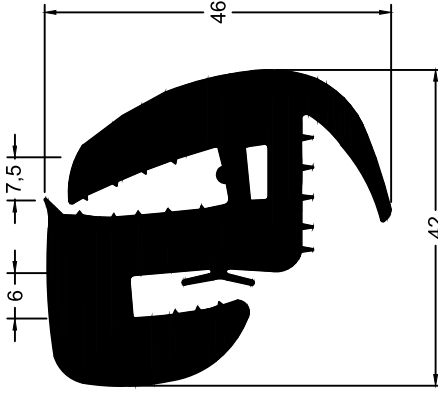

CIA 9160**

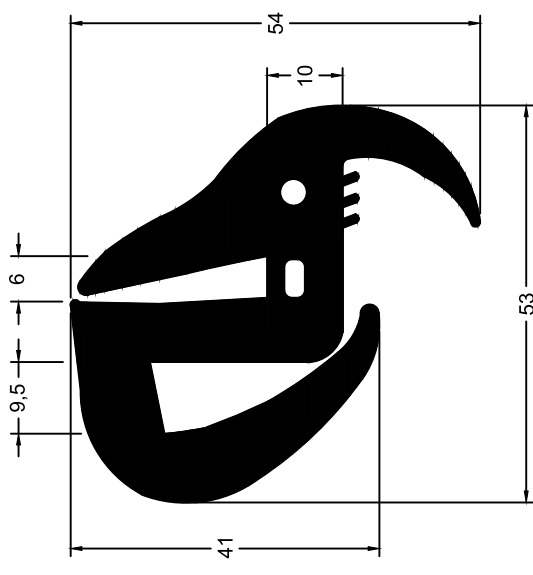

CIA 14804**

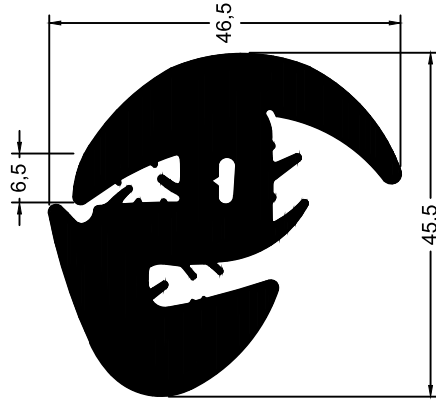

CIA 9139**

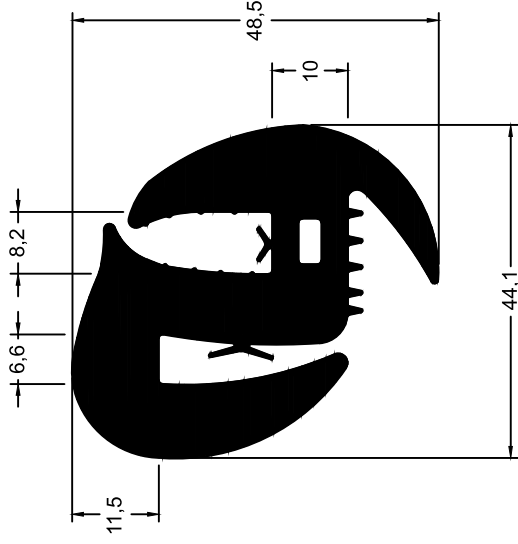

CIA 9100**

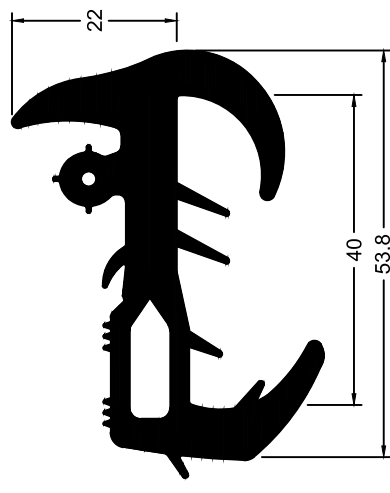

CIA 9024**

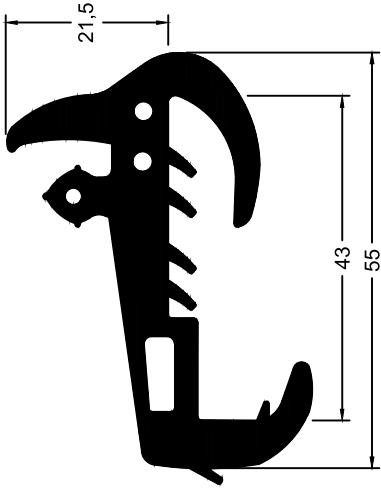

CIA 9102**

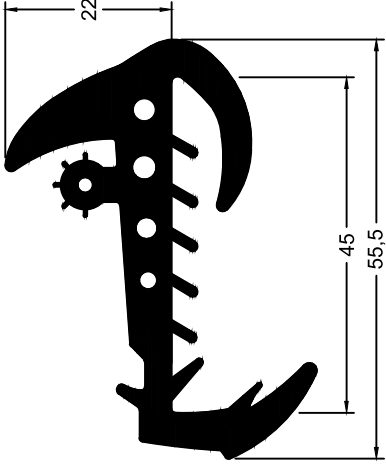

CIA 9120**

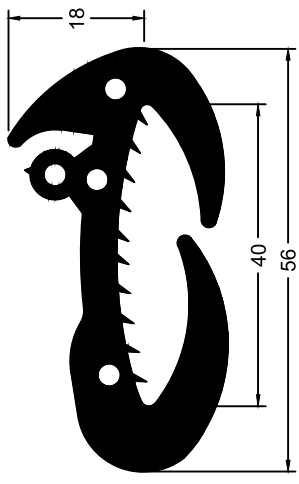

CIA 9127**

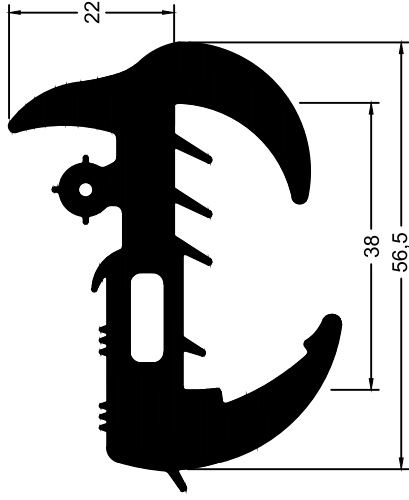

CIA 9115**

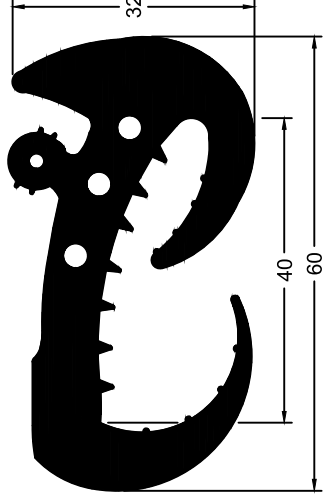

CIA 15467**

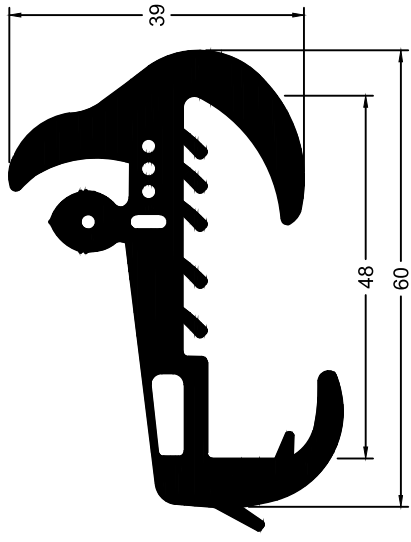

CIA 9159**

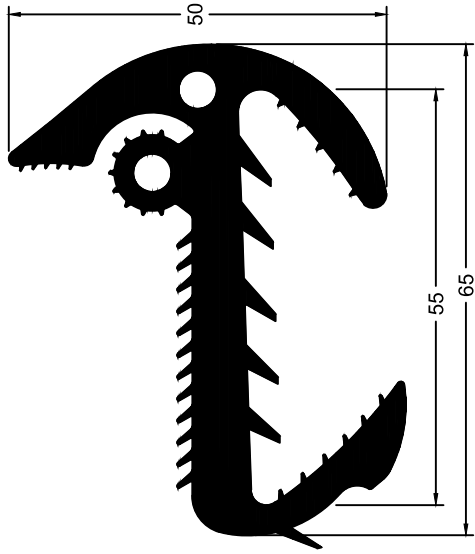

CIA 9090**

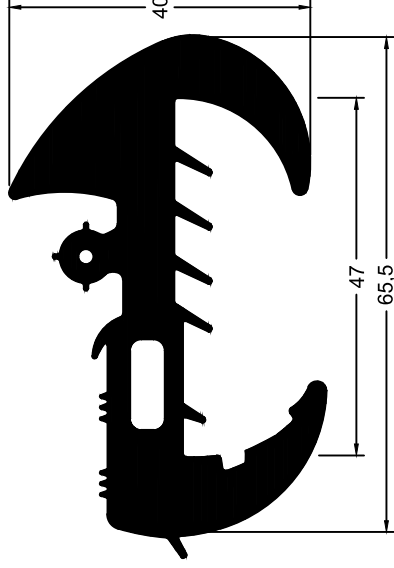

CIA 9126**

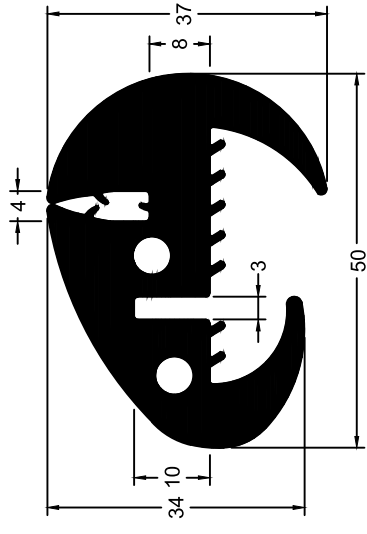

CIA 9158**

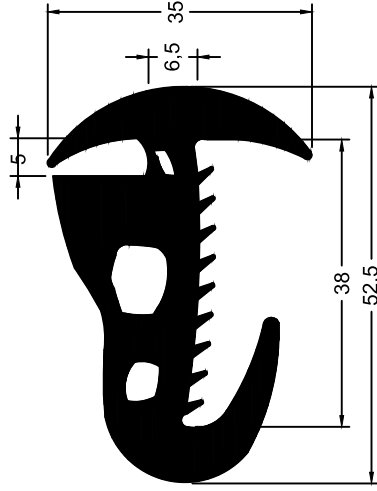

CIA 9042**

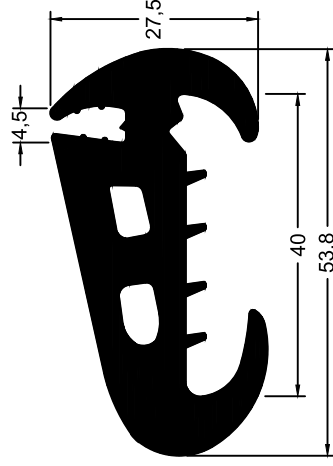

CIA 9147**

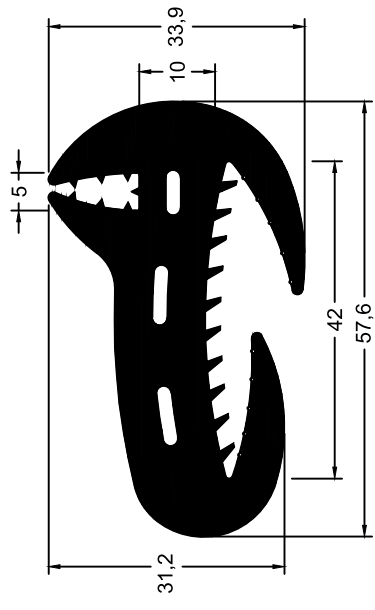

CIA 9148**

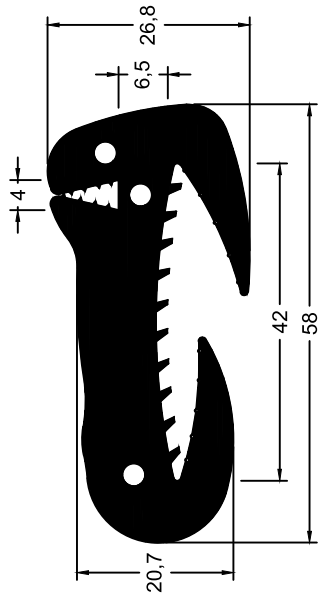

CIA 14697**

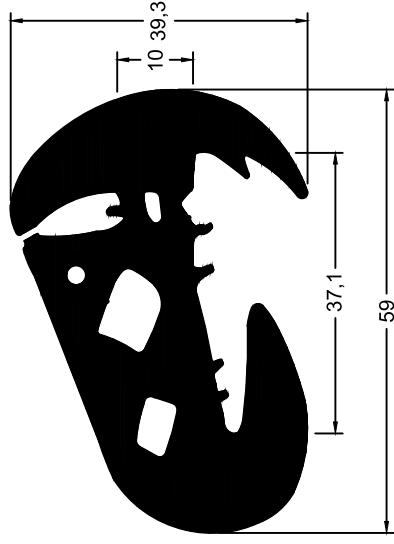

CIA 9114**

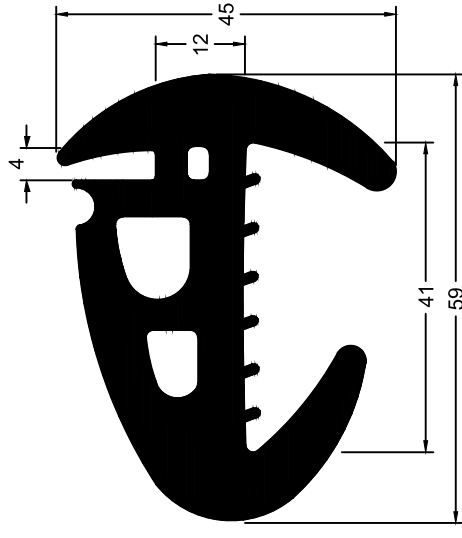

CIA 9083**

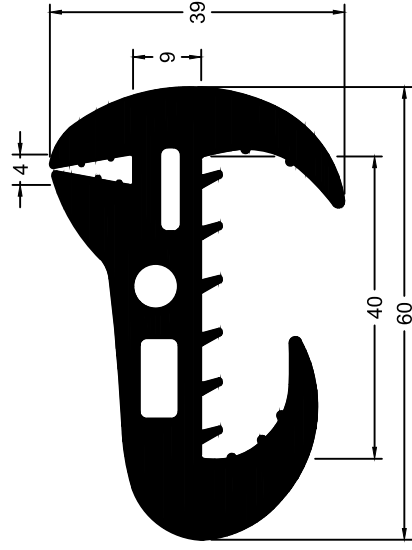

CIA 9161**

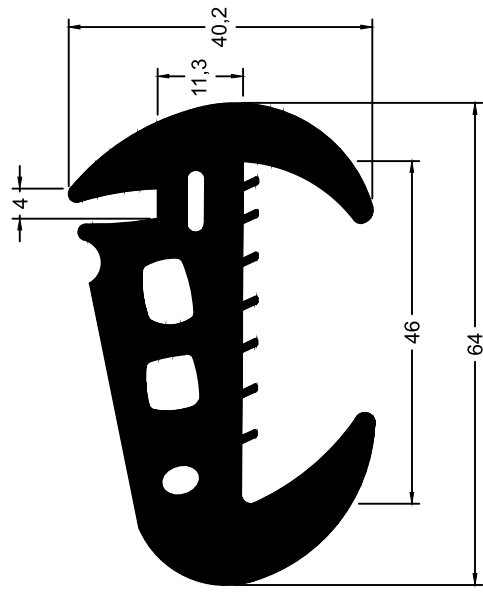

CIA 9121**

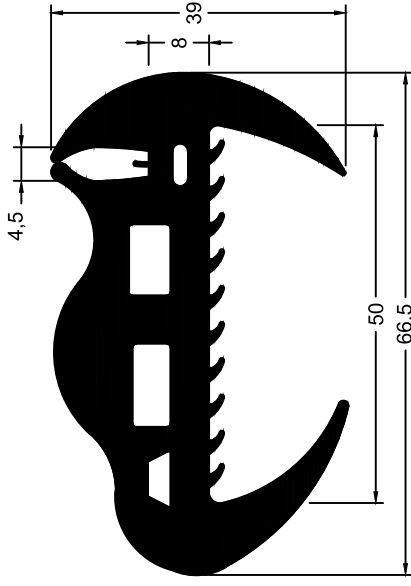

CIA 9140**

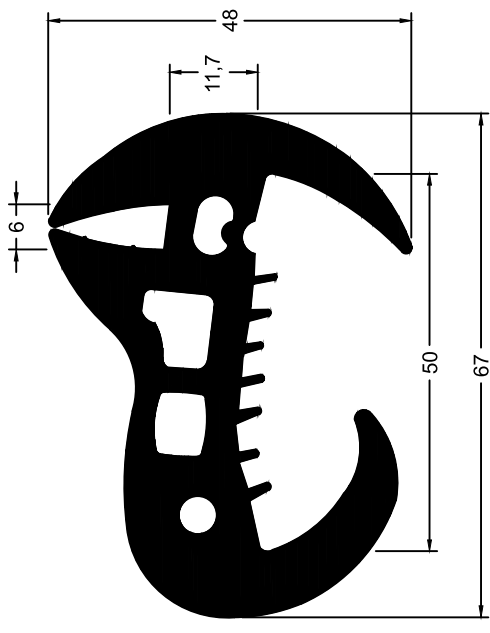

CIA 17263**

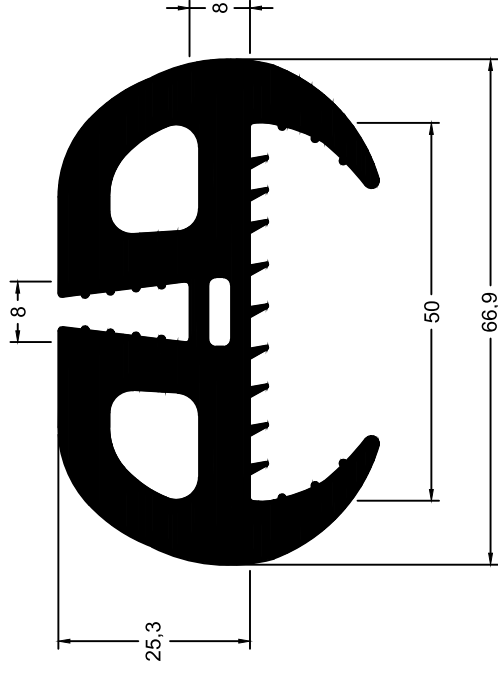

CIA 9130**

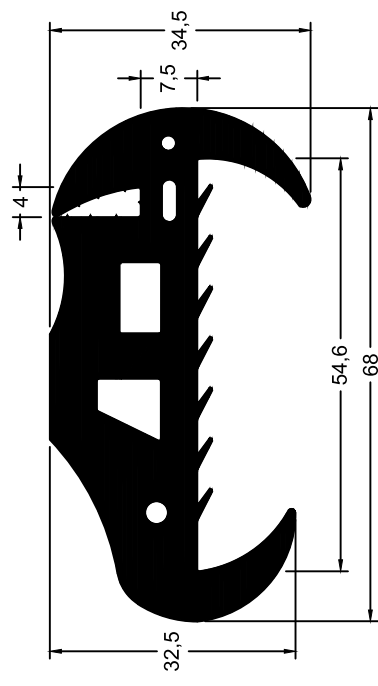

CIA 9097**

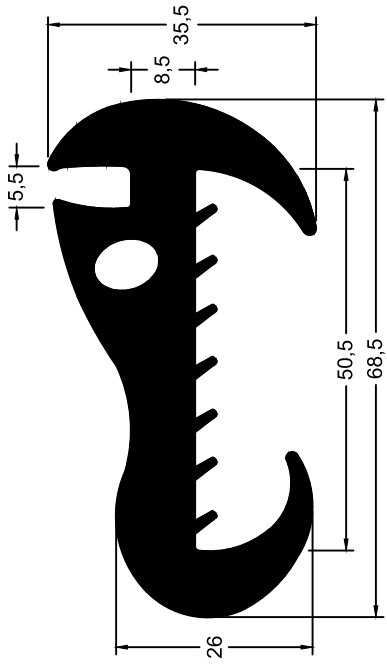

CIA 9137**

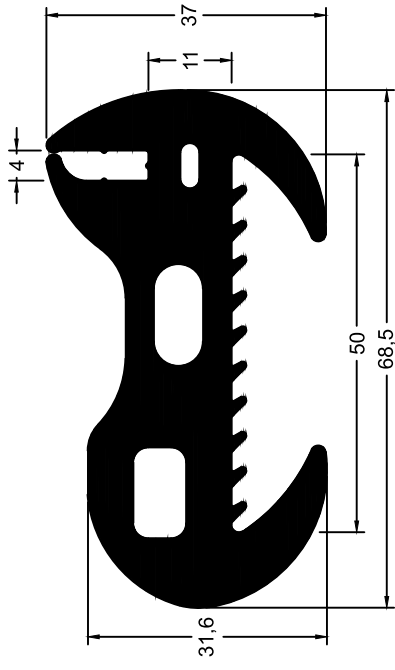

CIA 9145**

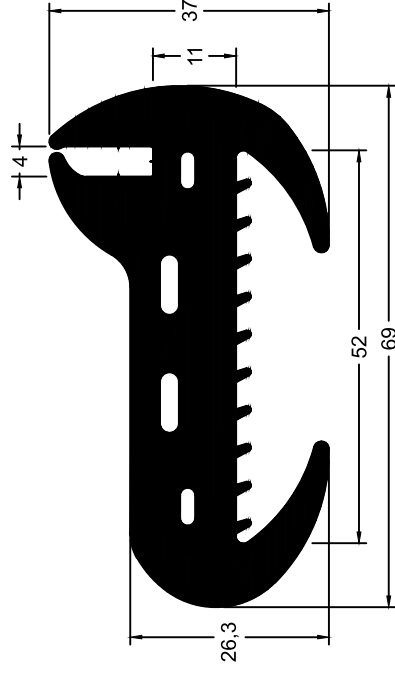

CIA 9129**

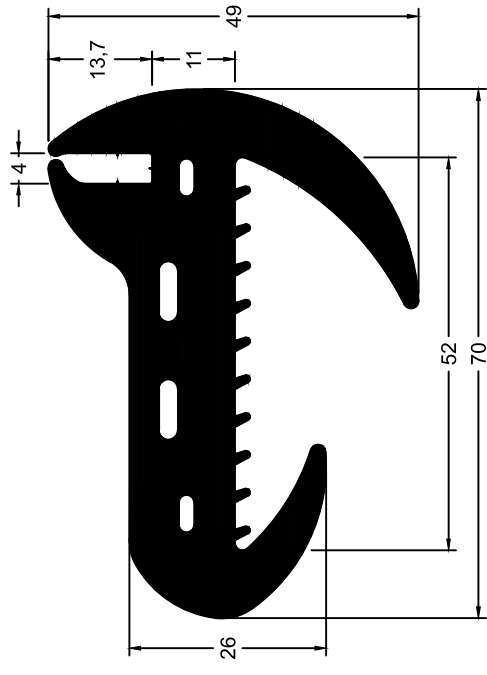

CIA 9092**

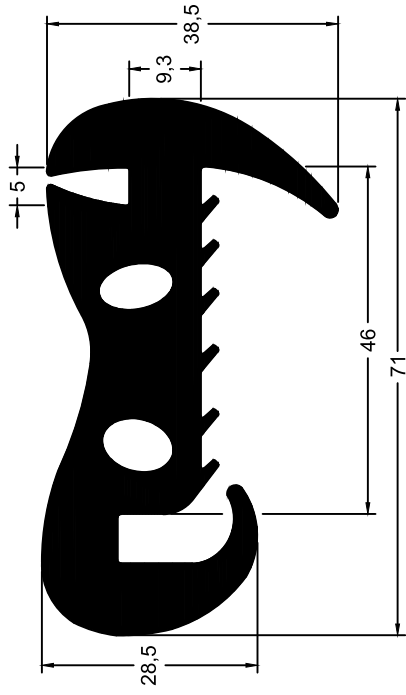

CIA 9123**

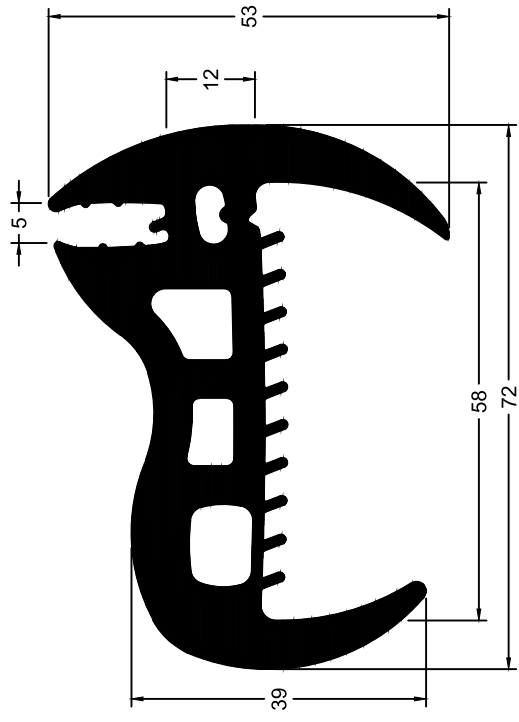

CIA 9153**

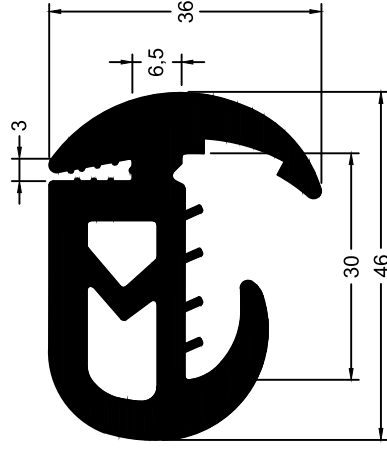

CIA 9040**

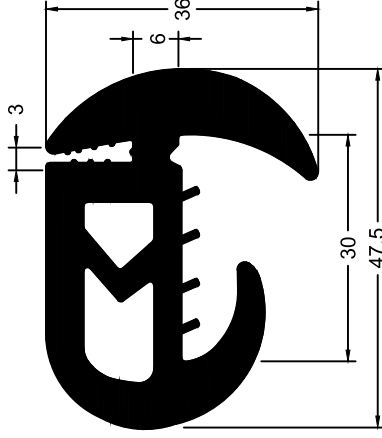

CIA 9152**

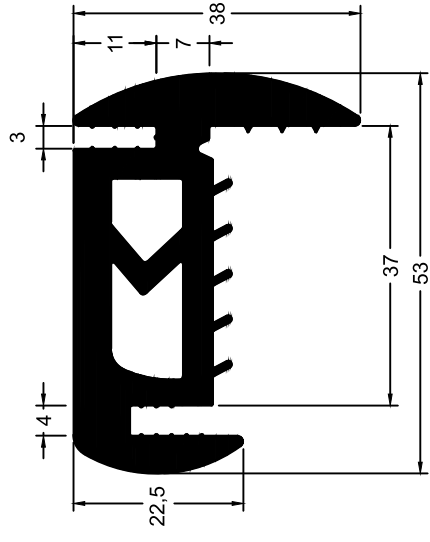

CIA 9072**

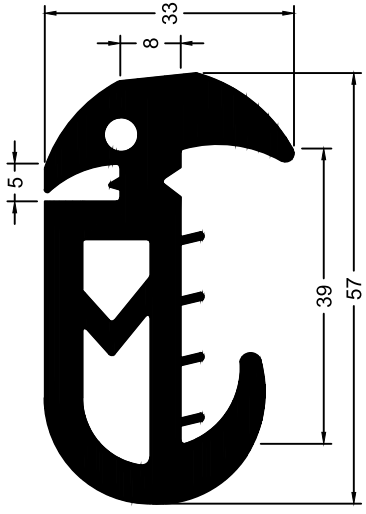

CIA 9064**

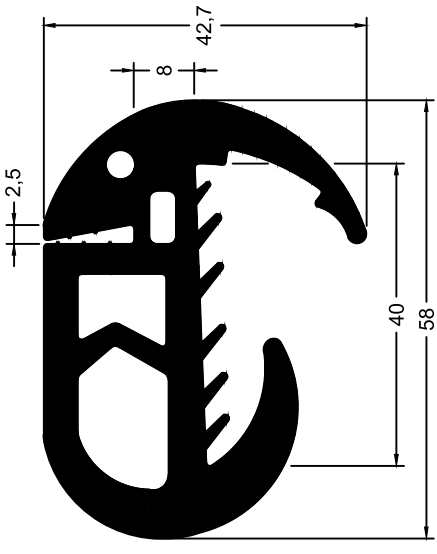

CIA 9051**

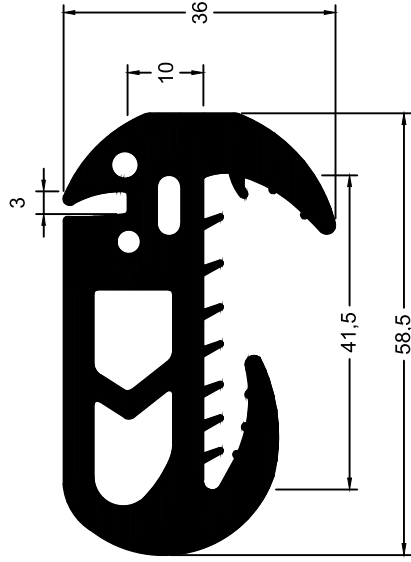

CIA 9069**

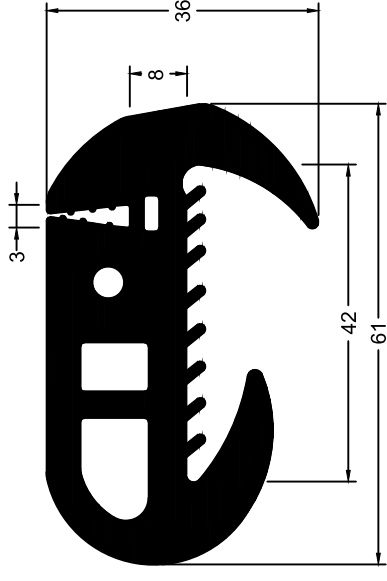

CIA 14882**

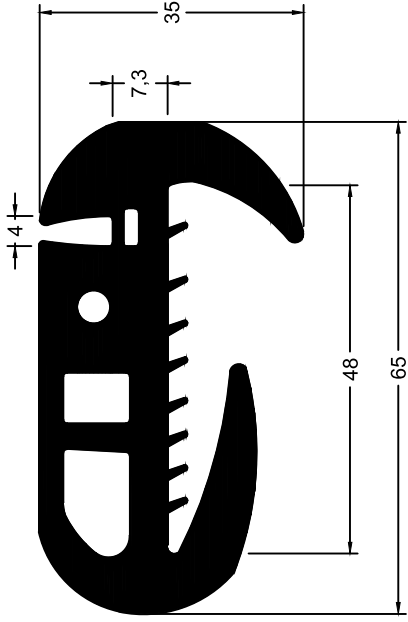

CIA 15423**

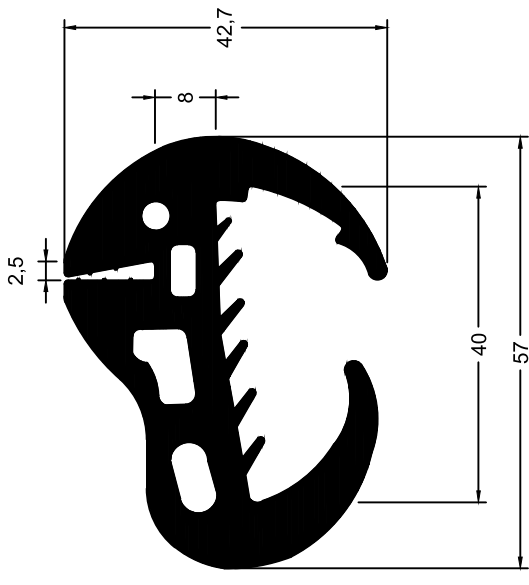

CIA 9003**

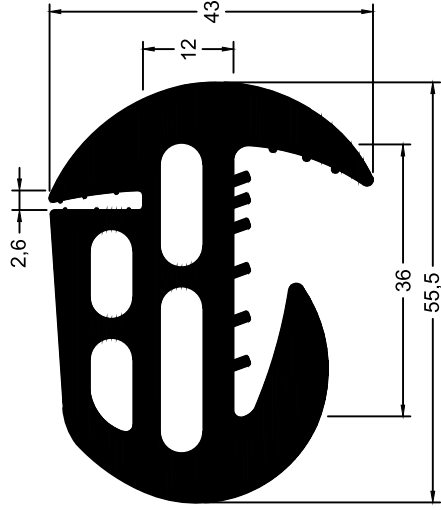

CIA 9088**

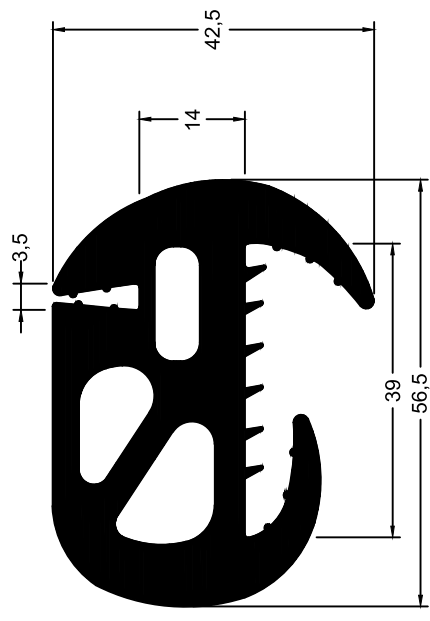

CIA 9020**

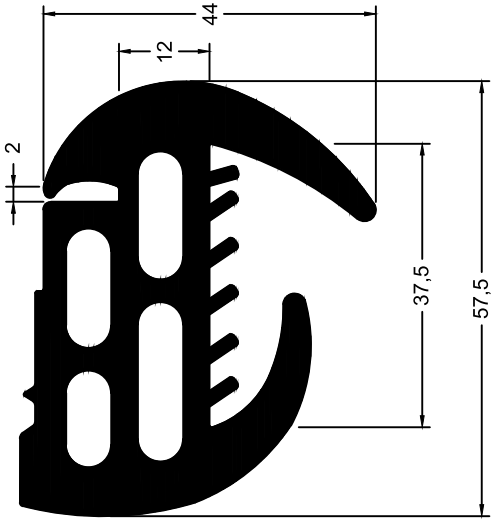

CIA 16022

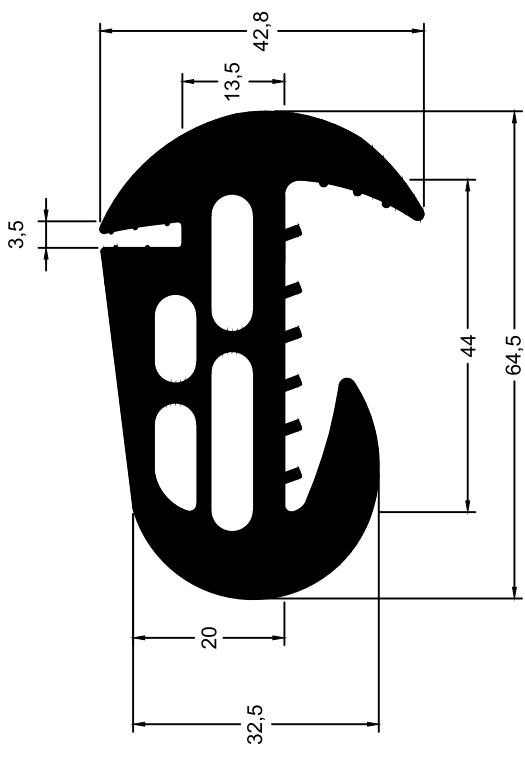

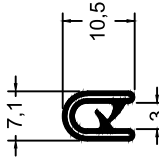
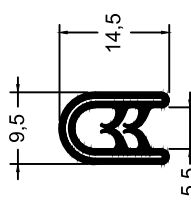
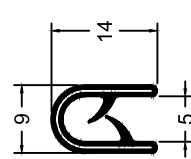
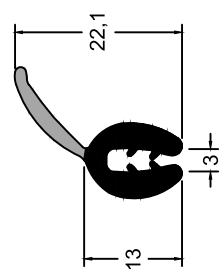
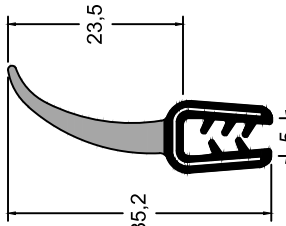
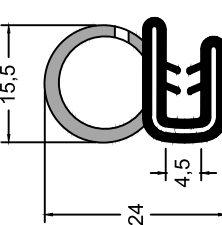
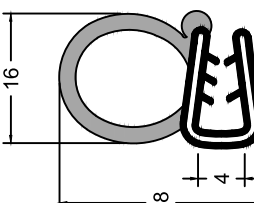
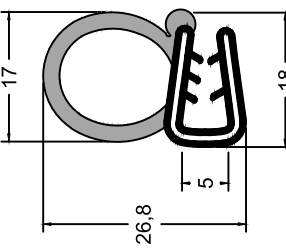
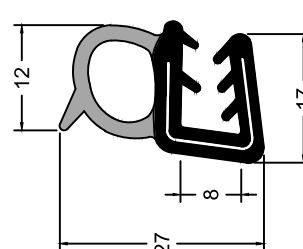
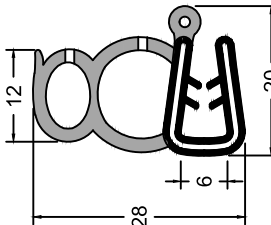
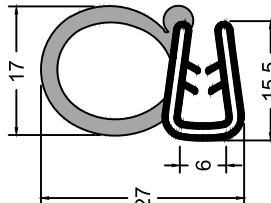
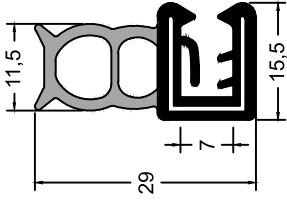
<p>CIA 16533 (PVC)</p> 	<p>CIA 0501 (PVC)</p> 	<p>CIA 16910 (PVC)</p> 	<p>CIA 16570</p> 
<p>CIA 16486</p> 	<p>CIA 0508</p> 	<p>CIA 16692</p> 	<p>CIA 0511</p> 
<p>CIA 0513</p> 	<p>CIA 0506</p> 	<p>CIA 0507</p> 	<p>CIA 0515</p> 

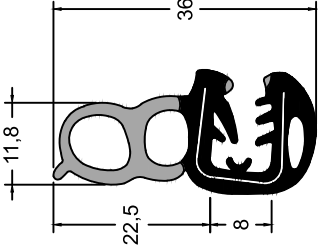
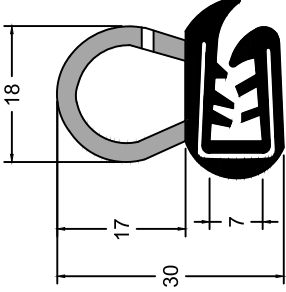
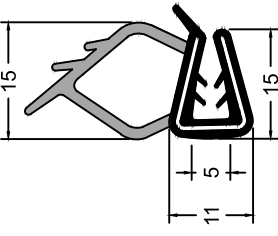
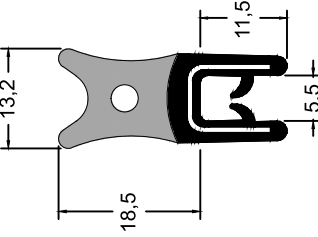
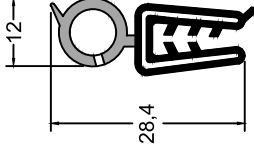
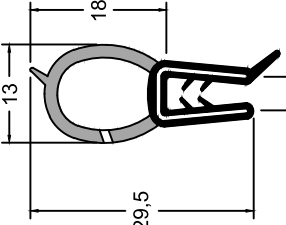
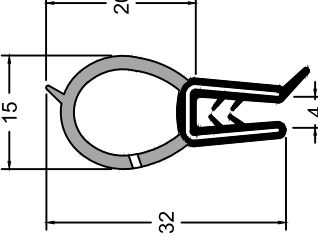
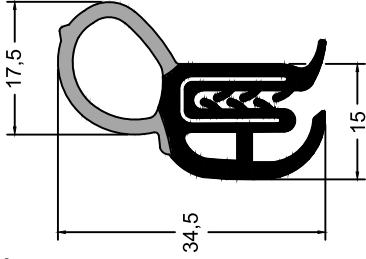
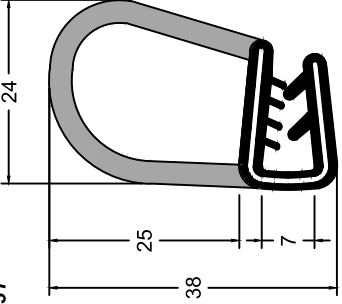
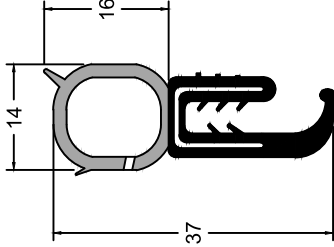
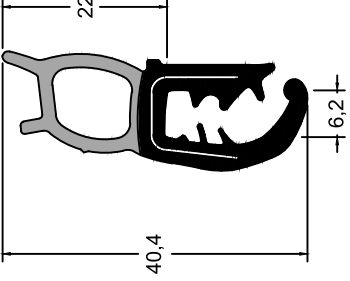
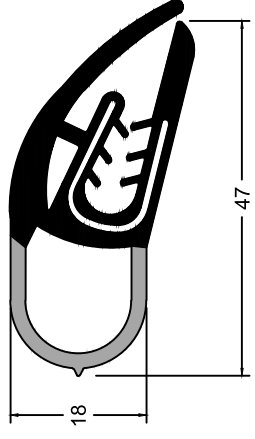
<p>CIA 17380</p> 	<p>CIA 14632</p> 	<p>CIA 14244</p> 	<p>CIA 16671</p> 
<p>CIA 0504</p> 	<p>CIA 16611</p> 	<p>CIA 0505</p> 	<p>CIA 0512</p> 
<p>CIA 14631</p> 	<p>CIA 0514</p> 	<p>CIA 17338</p> 	<p>CIA 0516</p> 

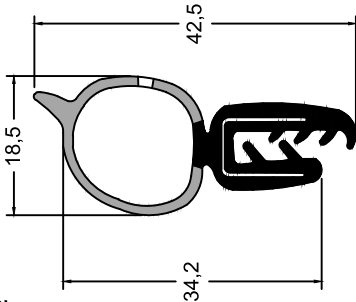
<p>CIA 15442</p> 			



INOVASUPRI

contato@inovasuprisjc.com.br

Tel.: 12 3911-2658

Whatsapp: 12 98852-8594